

Lecture 10

Nanometre resolution by Single Molecule Localization Microscopy

17 Nov 2016

Rainer Kaufmann
rainer@strubi.ox.ac.uk

localization microscopy – one technique, many acronyms

sptPALM GSDIM dSTORM d⁴STORM

PALM STORM rapidSTORM

P-FPALM

FPALM SPDM BALM

PALMIRA

RPM

SALM SOFI DAOSTORM

CHIRON

LOBSTER FIONA

PRILM 3B uPAINT

single molecule localization microscopy

Outline:

- introduction and general concept of single molecule localization microscopy
- first approaches: “original” (F)PALM and STORM
- dSTORM, SPDM, GSDIM – using standard fluorophores
- 3D
- live-cell (4D)
- quantitative analysis using the additional single molecule information
- alternative approaches
- conclusion

introduction to localization microscopy

problem in light microscopy: resolution limited by diffraction

$$\rightarrow I_{im}(x_2, y_2) = PSF \otimes P_{fl}(x_1, y_1)$$

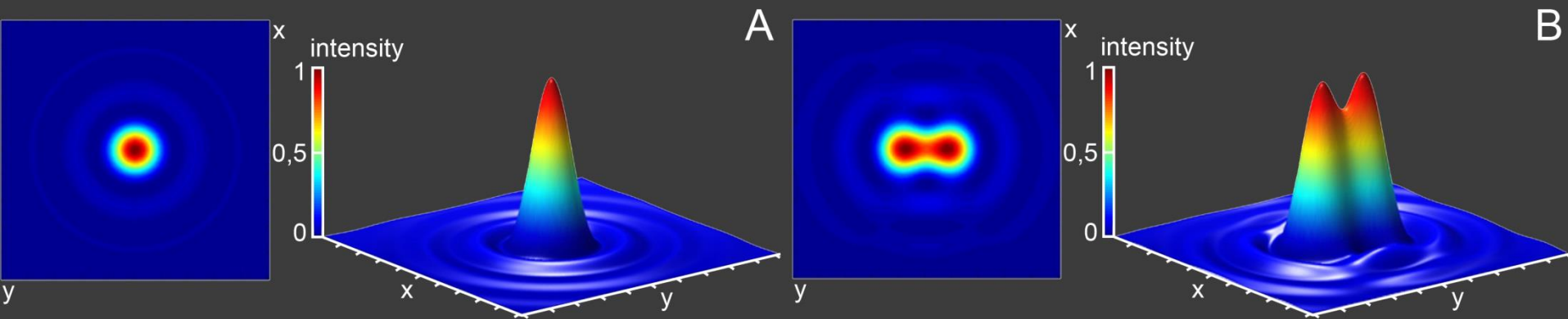

Rayleigh criterion: $D = 0.61 \frac{\lambda}{NA}$

introduction to localization microscopy

general idea:

look at signals of single molecules individually instead of all fluorophores at the same time

→ this allows a very precise determination of the molecule position

→ reconstruct super-resolution image from position data of the detected molecules

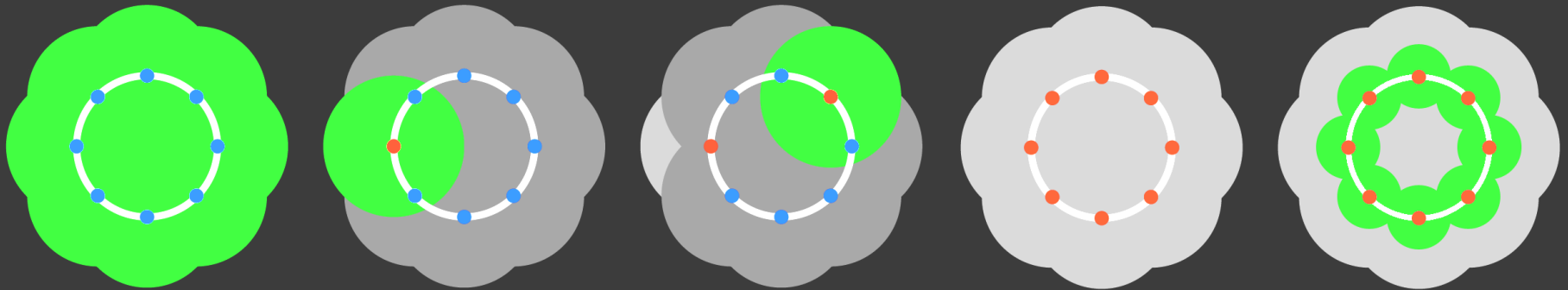

introduction to localization microscopy

setup

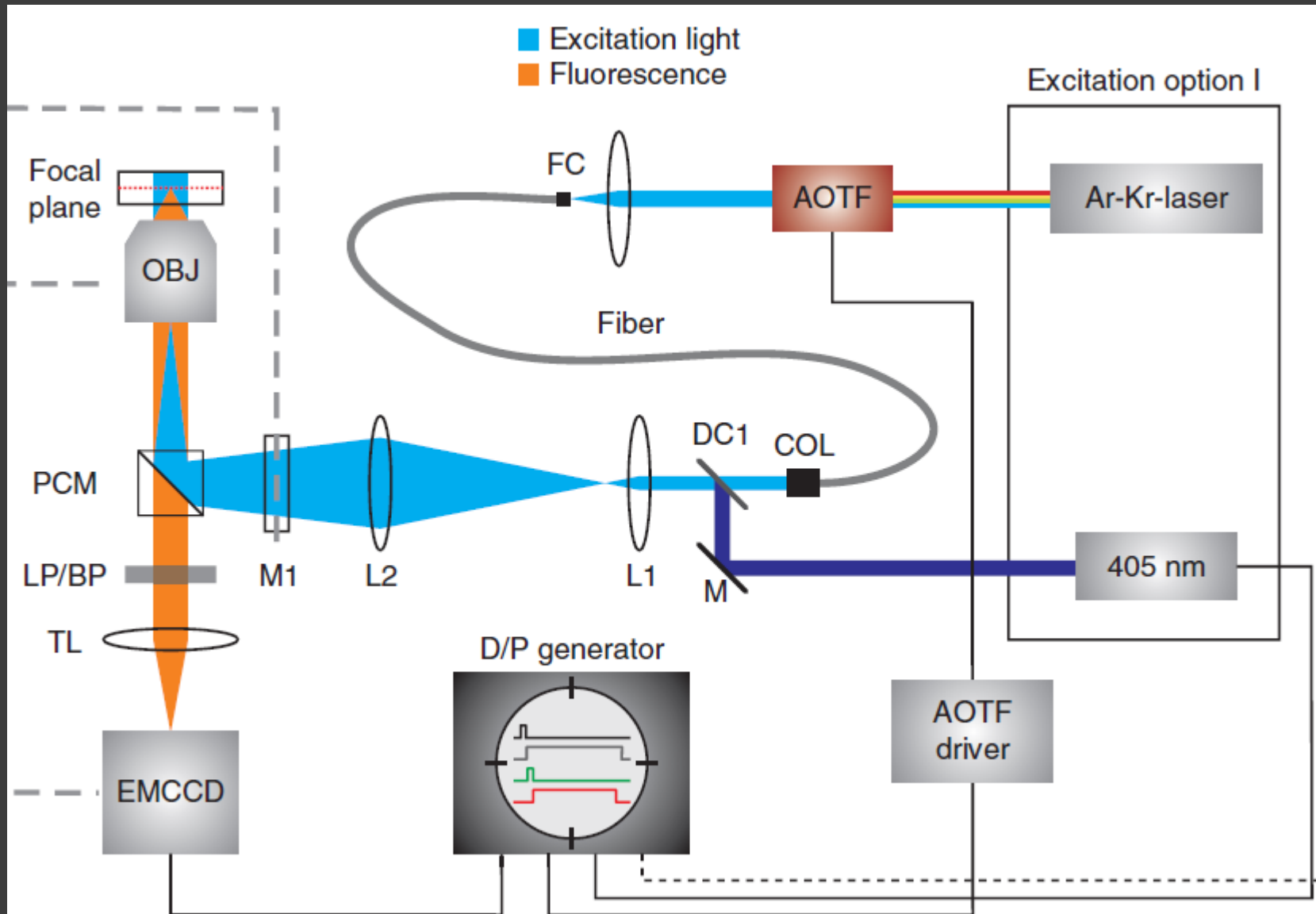

concept of localization microscopy

position determination

localisation accuracy σ of a single molecule is depended on

- width of the PSF s
- number of detected photons N
- background intensity b
- size of the pixels on the camera a

$$\sigma^2 = \frac{s^2 + a^2/12}{N} + \frac{8\pi s^4 b^2}{a^2 N^2}$$

typical model function: 2D Gaussian + linear background

$$I(x, y) = I_0 \exp \left[-\frac{(x - x_0)^2 + (y - y_0)^2}{2s^2} \right] + b$$

concept of localization microscopy

image reconstruction

localization mode

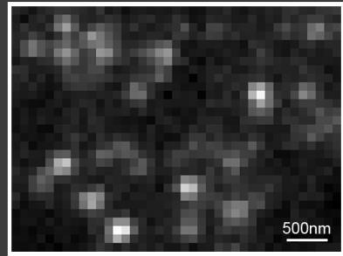

SPDM data stack

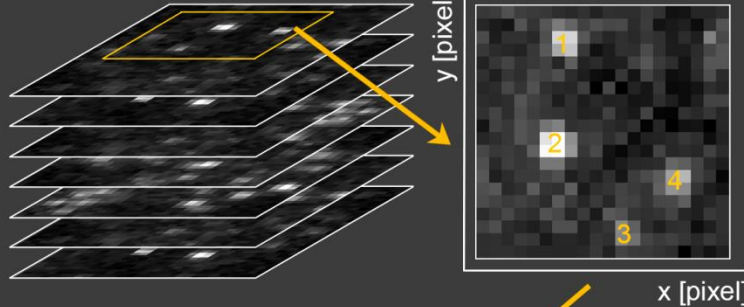

calculated confocal image

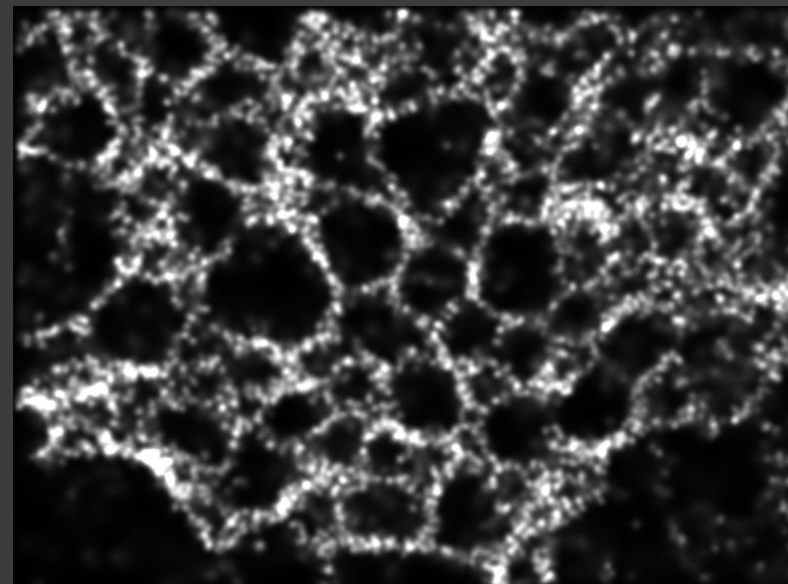
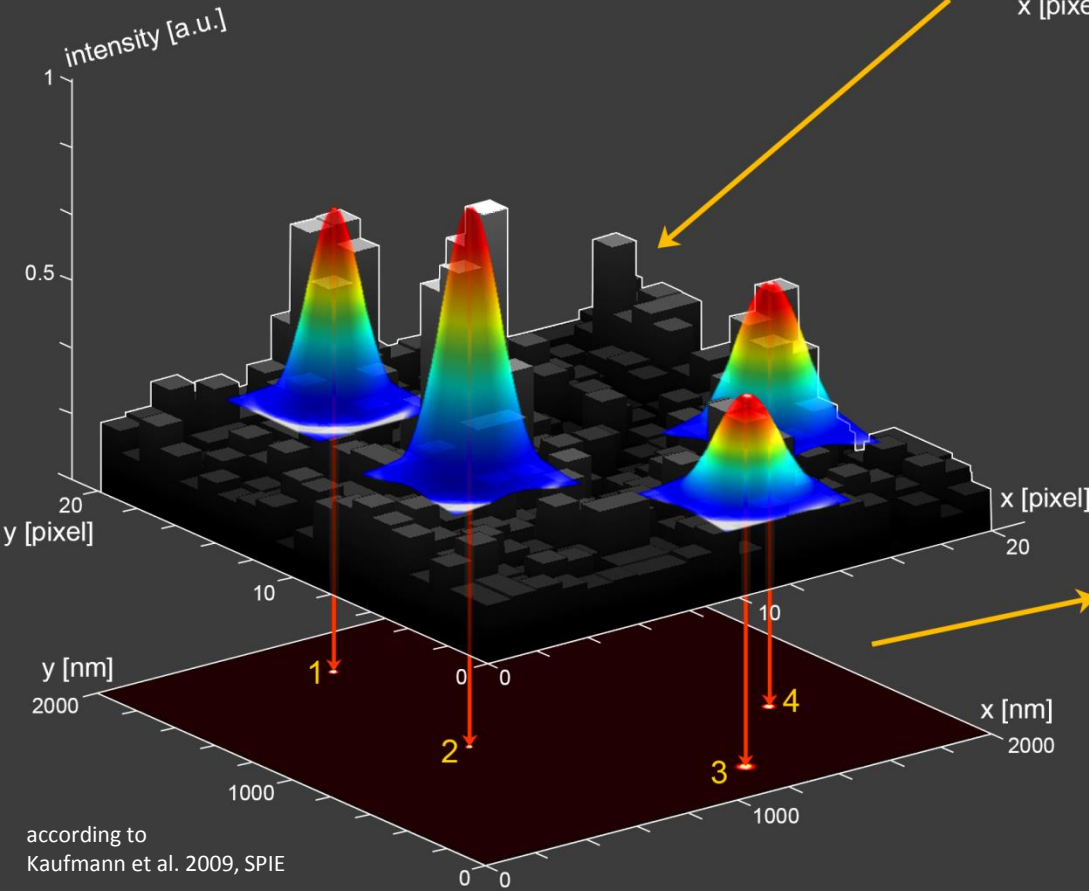

concept of localization microscopy

resolution

structural resolution in localization microscopy is dependent on:

- the **localization accuracy** of the individual molecules
- **density** of detected molecules (sampling theorem – Nyquist resolution)

$$\Rightarrow \text{structural resolution} = \sqrt{(2.355 \bar{\sigma}_{xy})^2 + (2 \bar{d}_{NN})^2}$$
$$= \sqrt{(2.355 \bar{\sigma}_{xy})^2 + 4/\rho}$$

$\bar{\sigma}_{xy}$: mean localization accuracy

\bar{d}_{NN} : mean distance to next neighboring molecule(s)

ρ : local density of detected molecules

concept of localization microscopy

resolution

structural resolution in localization microscopy is dependent on:

- the **localization accuracy** of the individual molecules
- **density** of detected molecules (sampling theorem – Nyquist resolution)

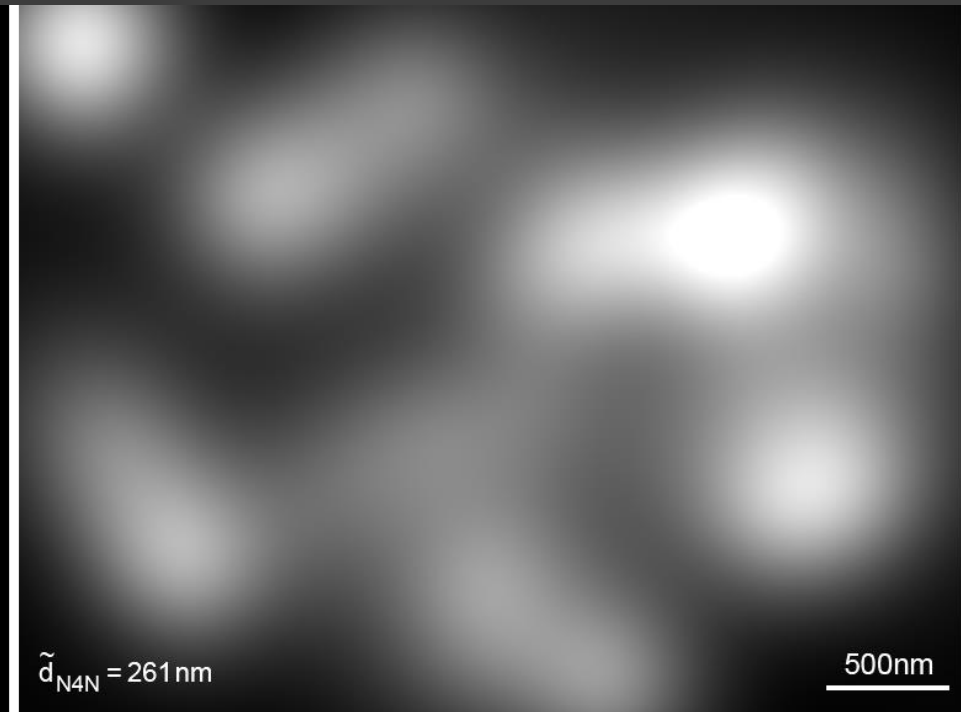
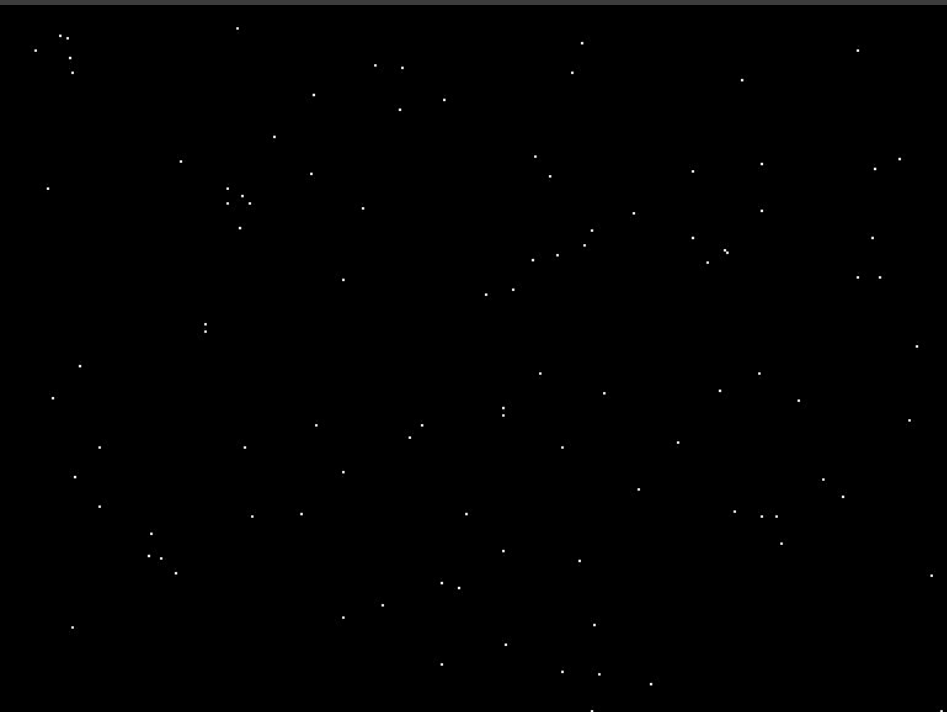

concept of localization microscopy

image reconstruction



scatter plot

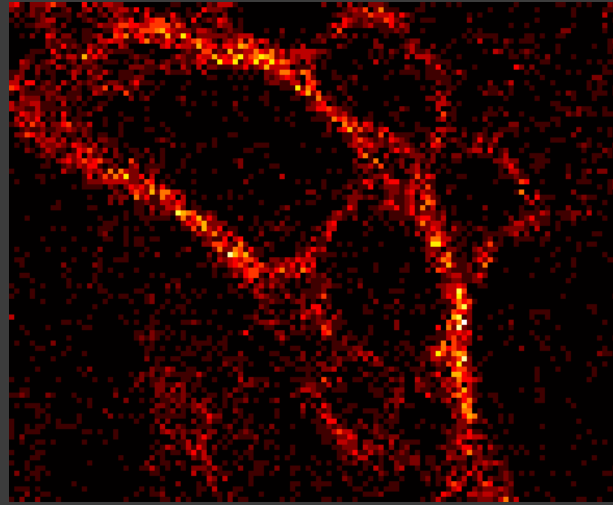

histogram with equal bins

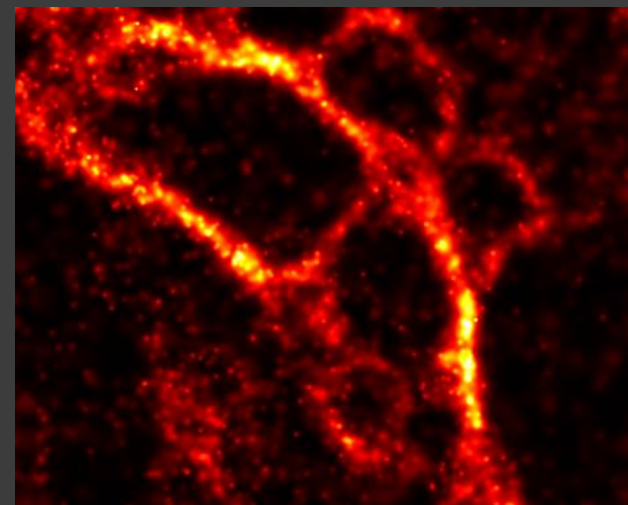

visualisation of σ_{xy}

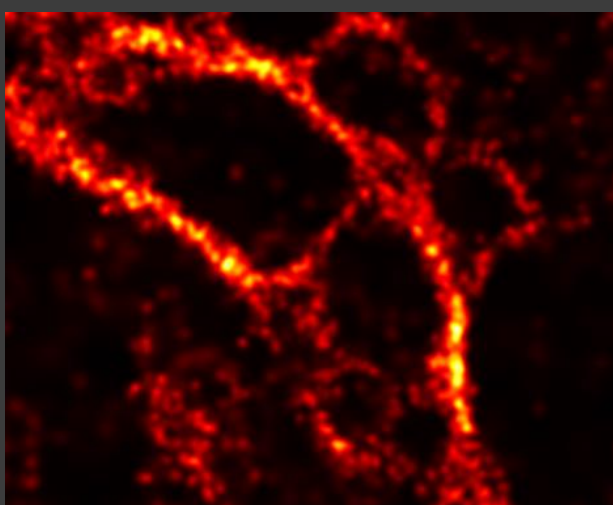

visualisation of structural resolution

more about visualisation of
localization microscopy data:

Baddeley et al., Microscopy
and Microanalysis, 2010

concept of localization microscopy

summary

enhanced structural resolution down the 10 nm range

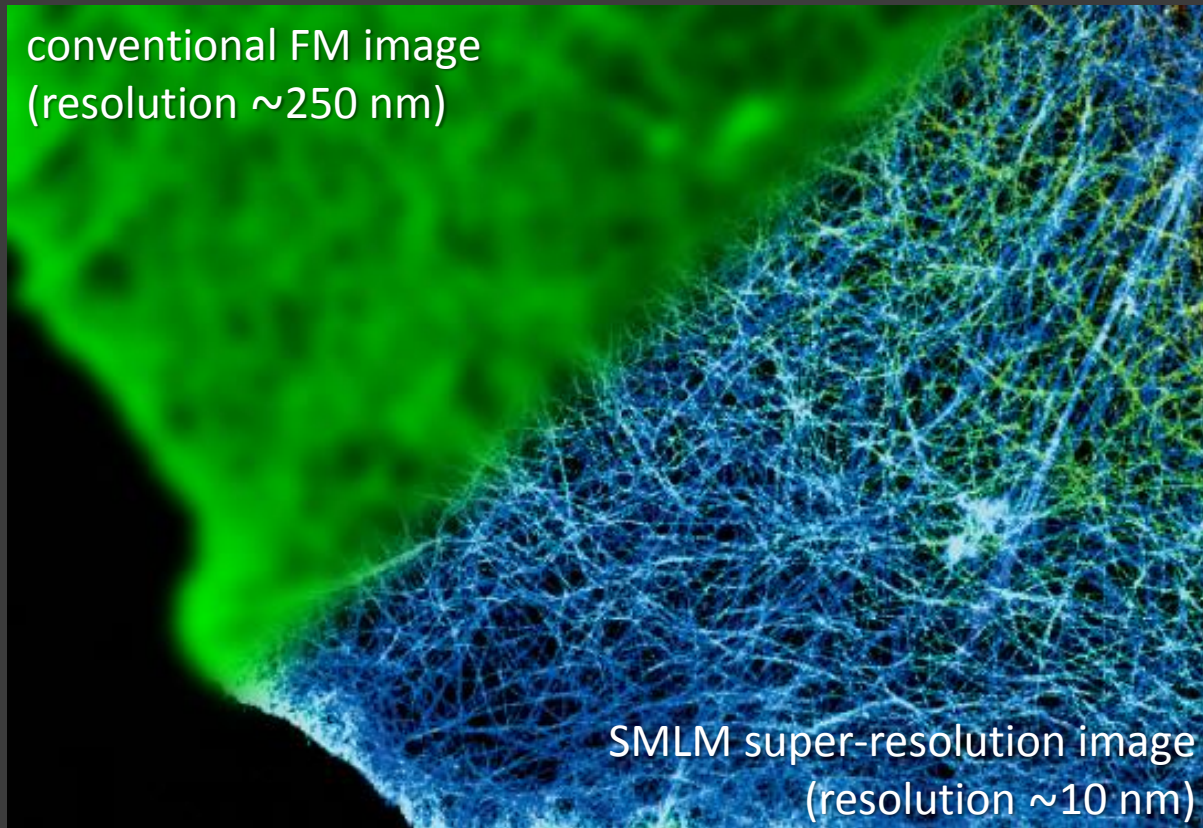

fluorophores are detected individually



single molecule information

- positions
- number of det. photons
- ...

(F)PALM and STORM

(some) history of localization microscopy

localization of single molecules / point-like objects

- | | |
|------------------------|---|
| Burns et al., 1985 | theoretical paper about super-resolution distance measurements using spectral characteristics |
| Betzig, 1995 | first measurements with SNOM under cryo conditions |
| Bornfleth et al., 1998 | CLSM measurements of 3D distances < 60 nm using fluorescent markers of different wavelengths (@ RT) |
| Heilemann et al., 2002 | using single molecule live time instead of colours to measure distances of 40 nm |

localization of many molecules to reconstruct structural information

2006: (PALM, FPALM, STORM) – photo-switchable / photo-activatable fluorescent molecules

2008: (dSTORM, SPDM, GSDIM) – using standard fluorophores

(F)PALM – (fluorescence) photo activated localization microscopy

uses **photo-activatable fluorophores** (e.g. PA-GFP, caged Fluorescein, ...)

- at the beginning all fluorophores are “dark” (not fluorescent at their excitation wavelength)
- fluorophores can be “activated” to a “bright” state
- after bleaching the molecules they do not reappear

→ **irreversible process**

original publications:

- PALM: Betzig et al., Science, 2006
- FPALM: Hess et al., Biophysical Journal, 2006

(F)PALM – (fluorescence) photo activated localization microscopy

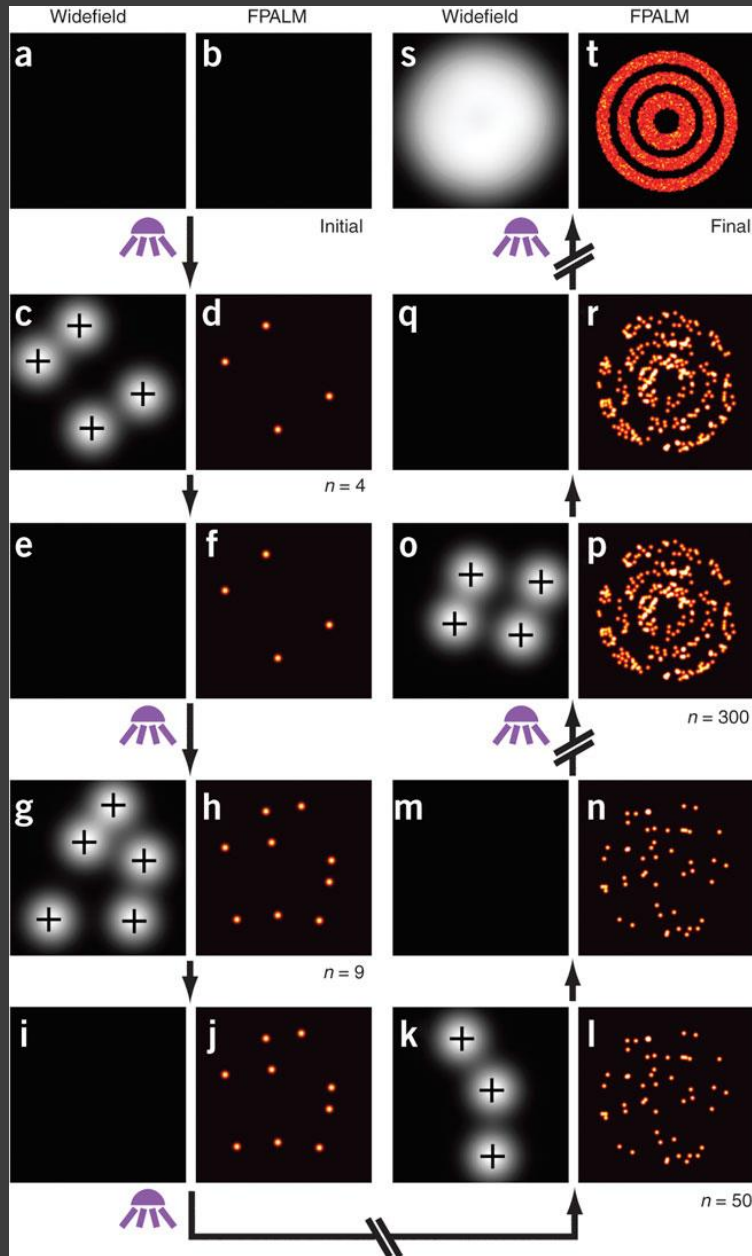

Gould et al., Nature Protocols, 2009

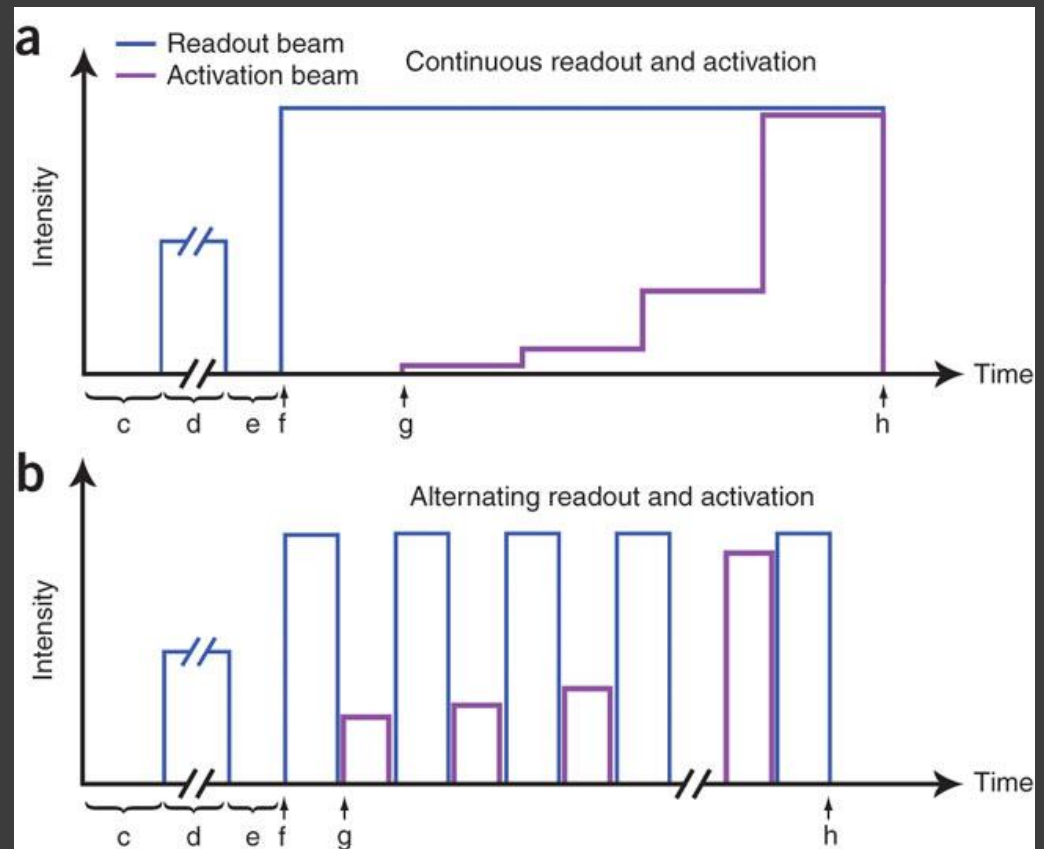

(F)PALM – (fluorescence) photo activated localization microscopy

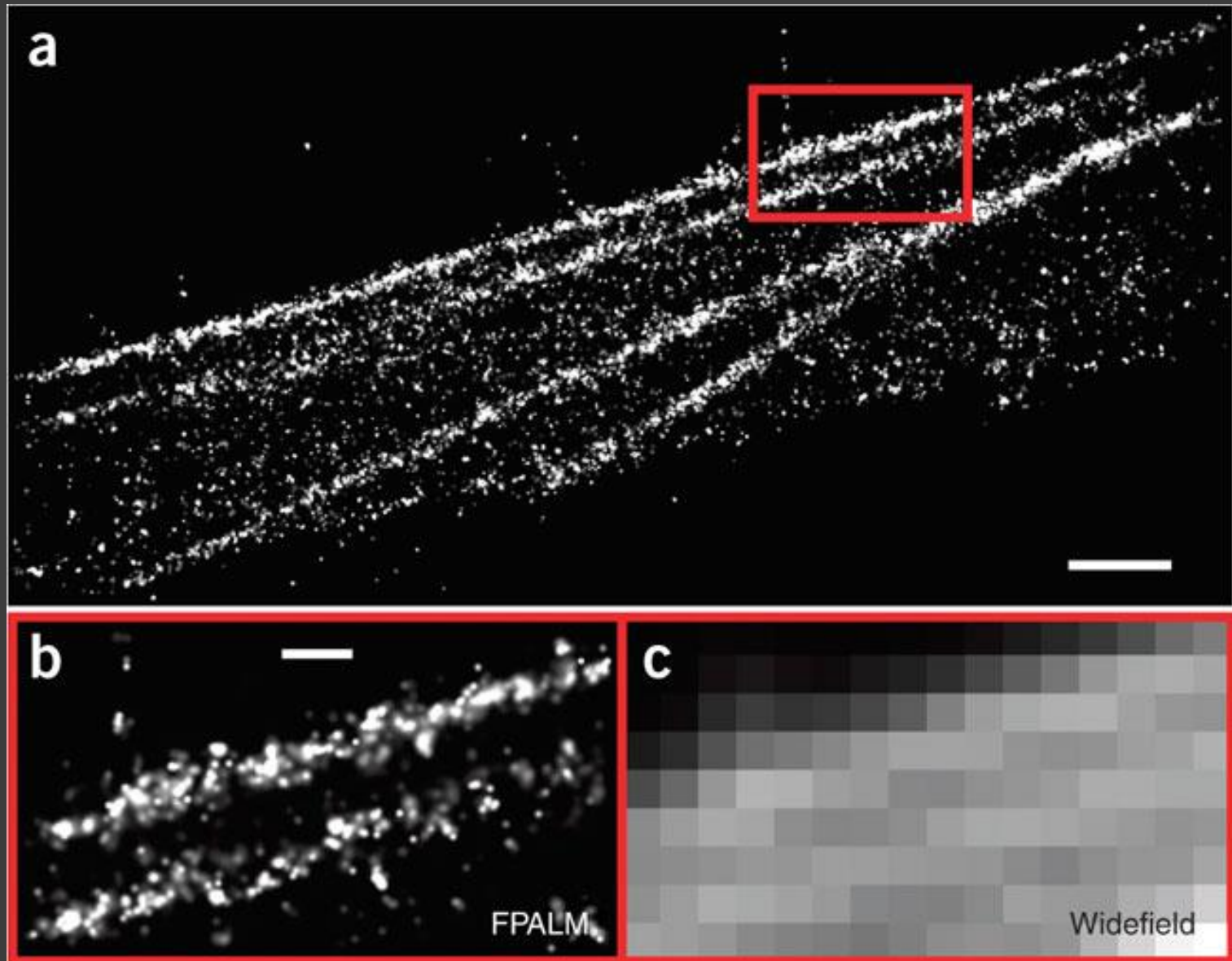

STORM – stochastic optical reconstruction microscopy

uses **photo-switchable fluorophores** (dye pairs (e.g. Cy3-Cy5) or proteins like Dronpa)

- fluorophores can be switched many times between a “bright” and a “dark” state

→ reversible process

original publication:

- Rust et al., Nature Methods, 2006

STORM – stochastic optical reconstruction microscopy

a

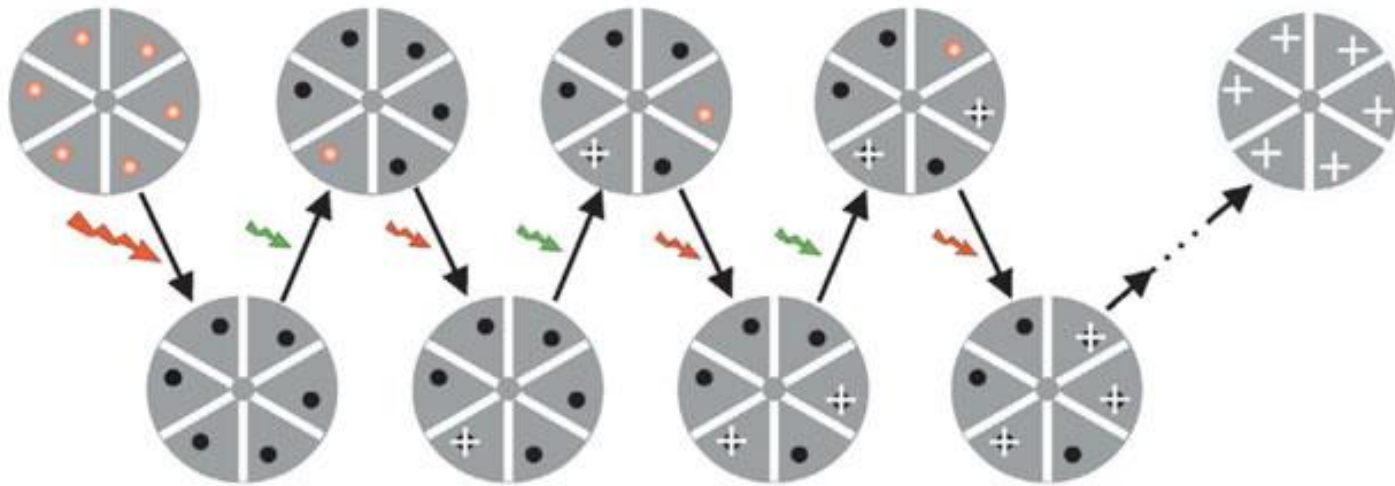

b

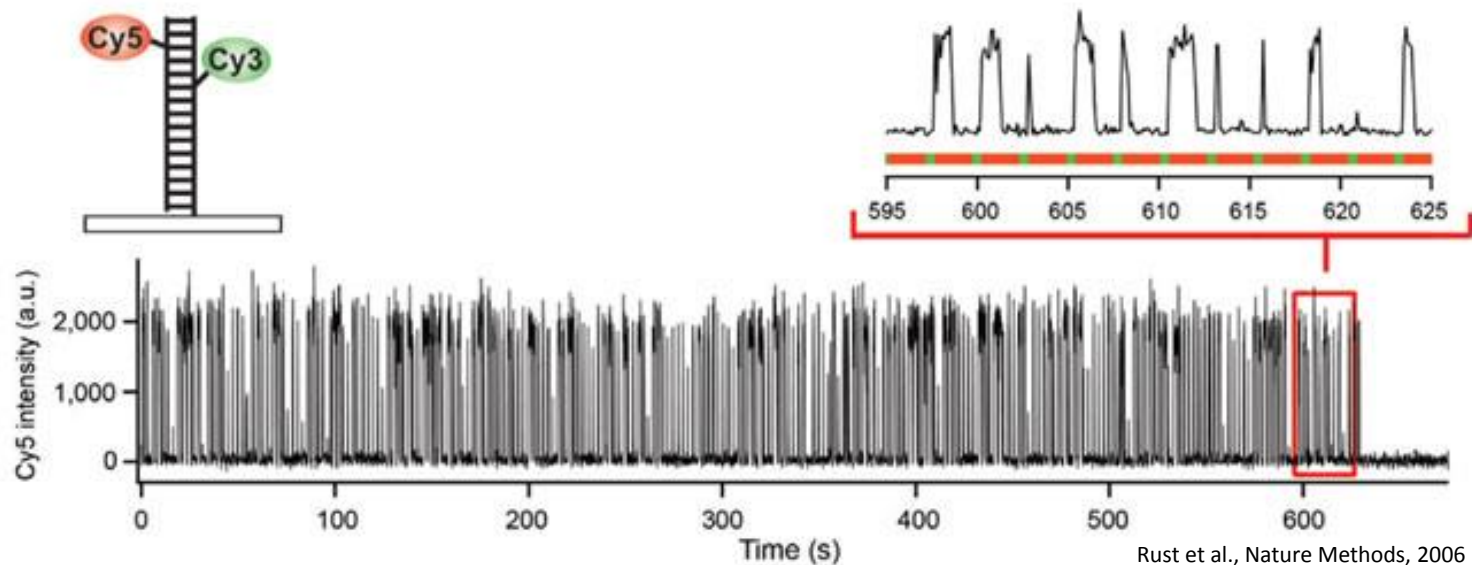

STORM – stochastic optical reconstruction microscopy

Bates et al., Science, 2007

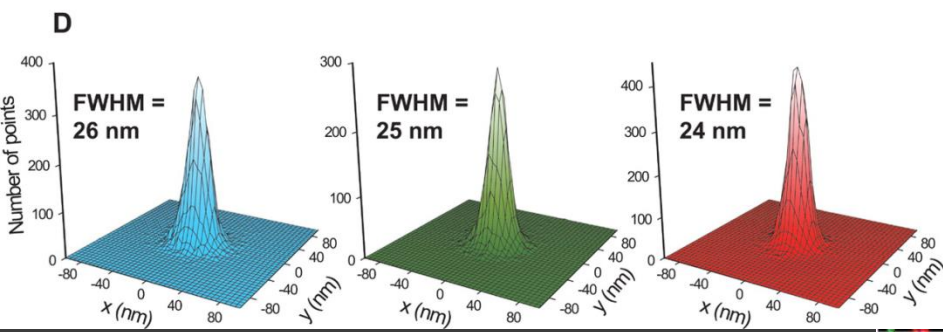
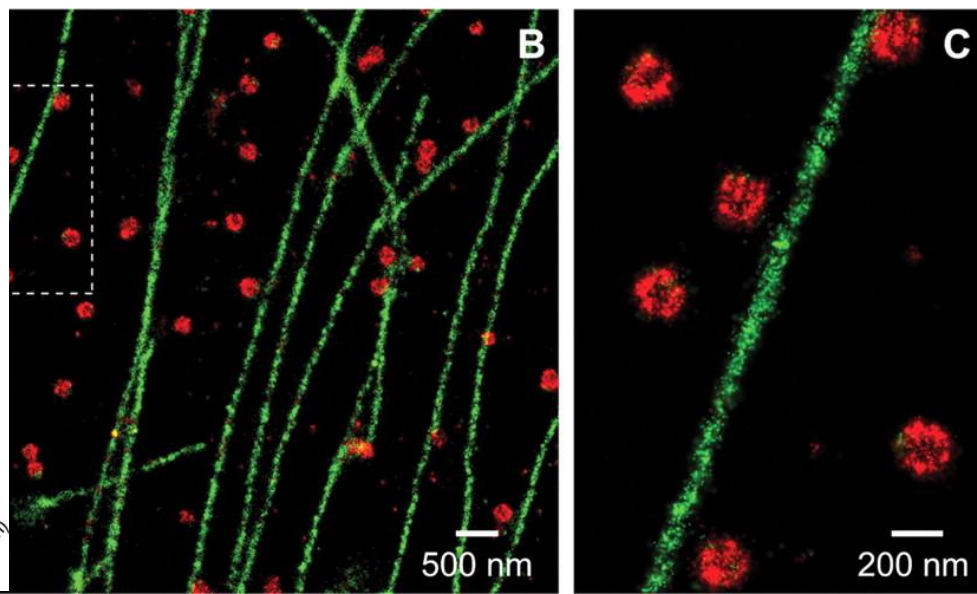
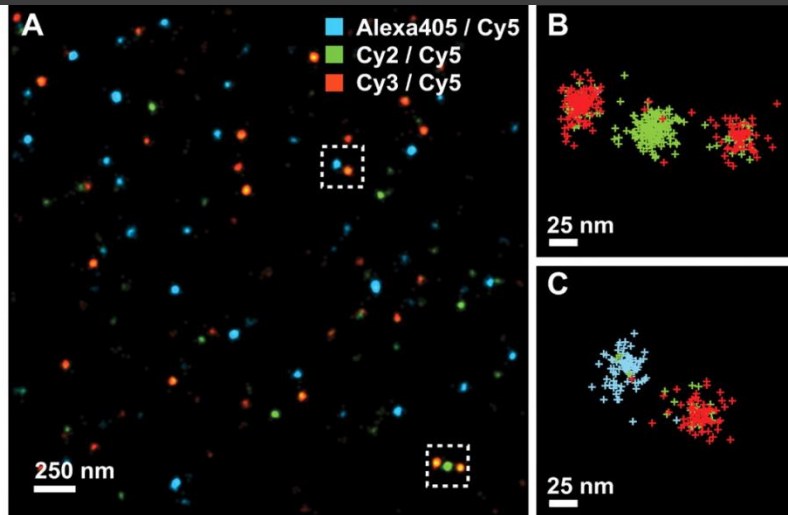
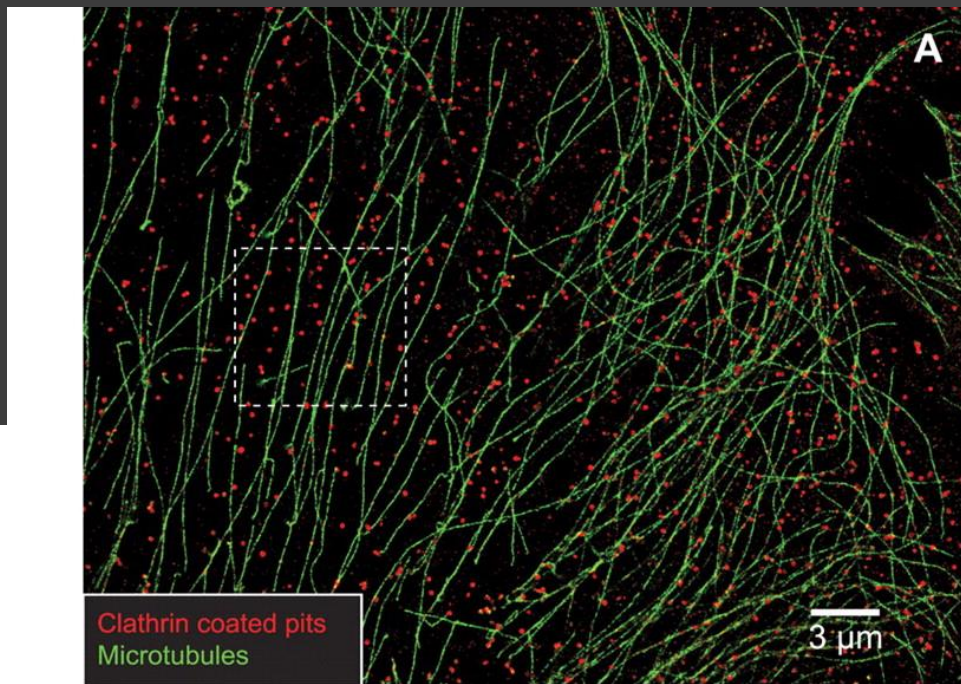

dSTORM, SPDM, GSDIM, ...

dSTORM, SPDM, GSDIM, ...

direct STORM

spectral position determination microscopy

ground state depletion microscopy followed by individual molecule return

uses **standard fluorophores** (e.g. Alexa and Atto dyes, GFP, YFP, RFP, ...)

- switching mechanism based on **a light induced long-lived “dark” state**
- stochastic recovery to “bright” (fluorescent) state is used for optical isolation of the single molecule signals

original publication:

- dSTORM: Heilemann et. al., Angewandte Chemie International Edition, 2008
- SPDM: Lemmer et al., Applied Physics B, 2008
- GSDIM: Fölling et al., Nature Methods, 2008

dSTORM, SPDM, GSDIM, ...

light induced long-lived (ms – 100 s) dark state

critical parameters for driving fluorophores into the long-lived dark state:

- illumination intensity
- wavelength
- embedding medium

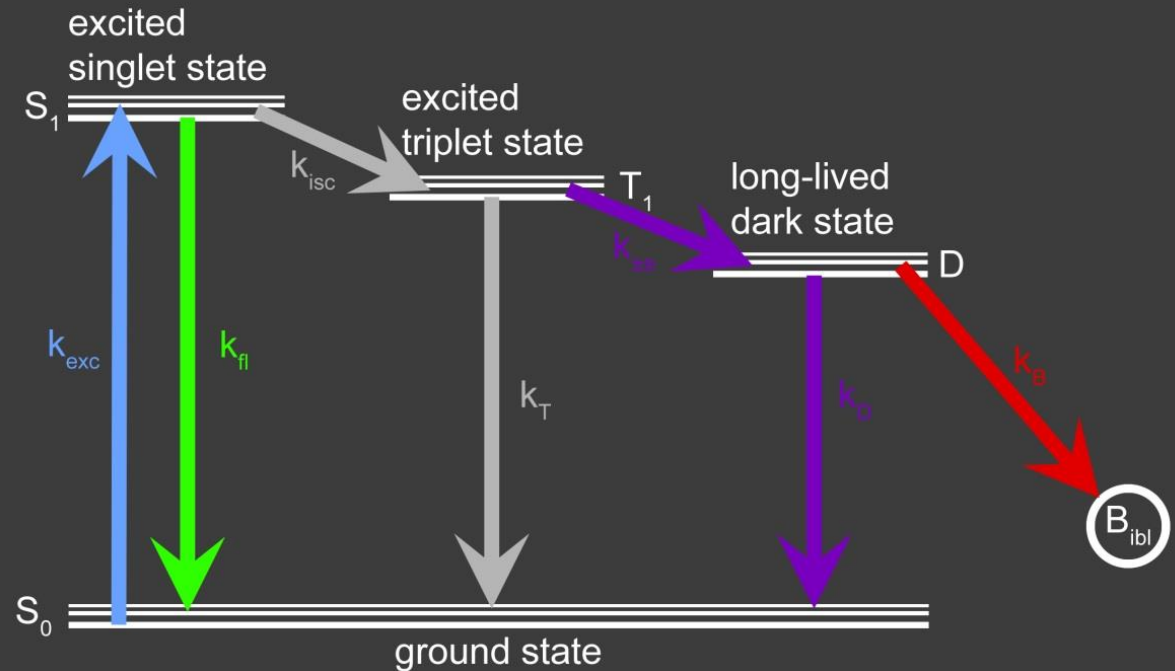

statistical recovery of fluorophores from the light induced long-lived dark state can be used for **optical isolation** of single molecules

dSTORM, SPDM, GSDIM, ...

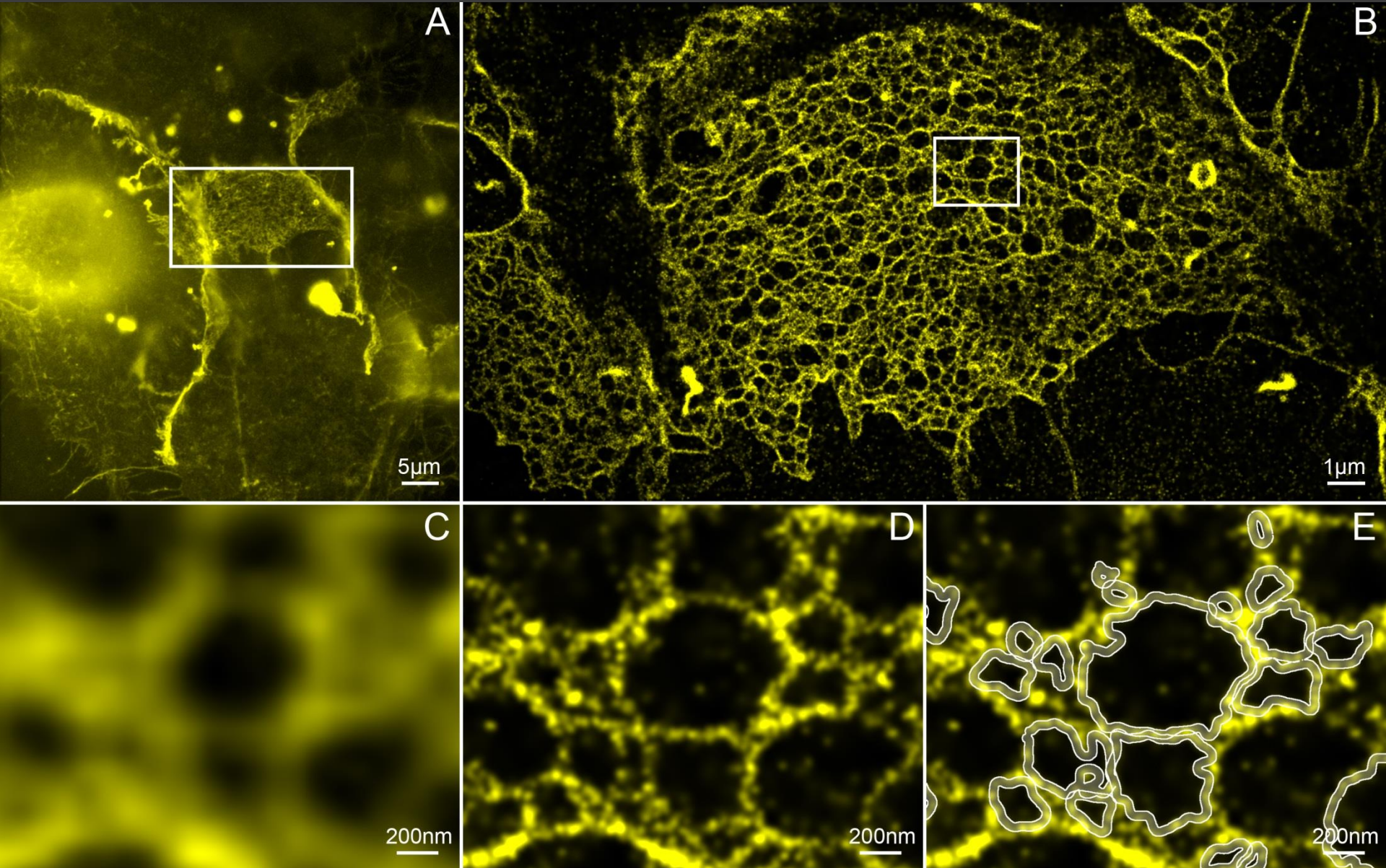

3D

astigmatic (elliptical) PSF

biplane

double helical PSF

iPALM

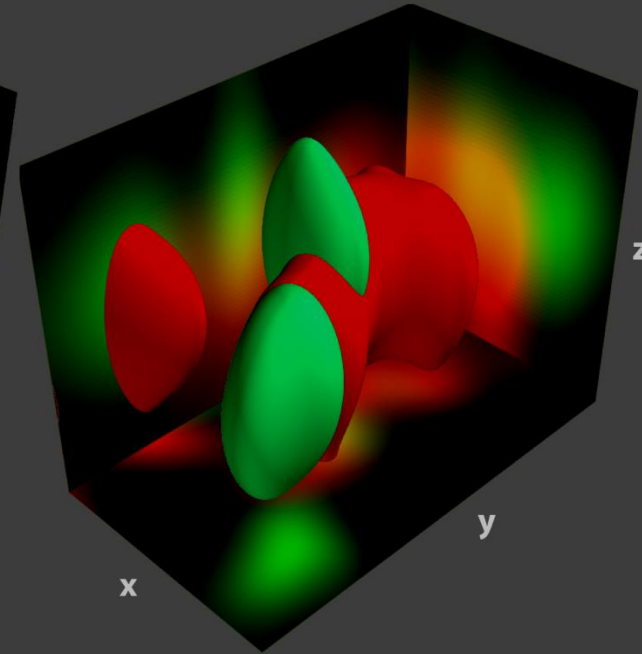
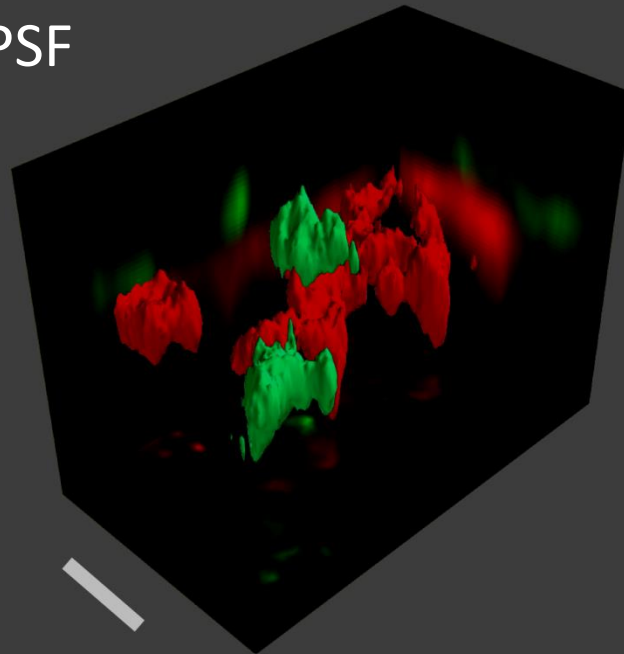

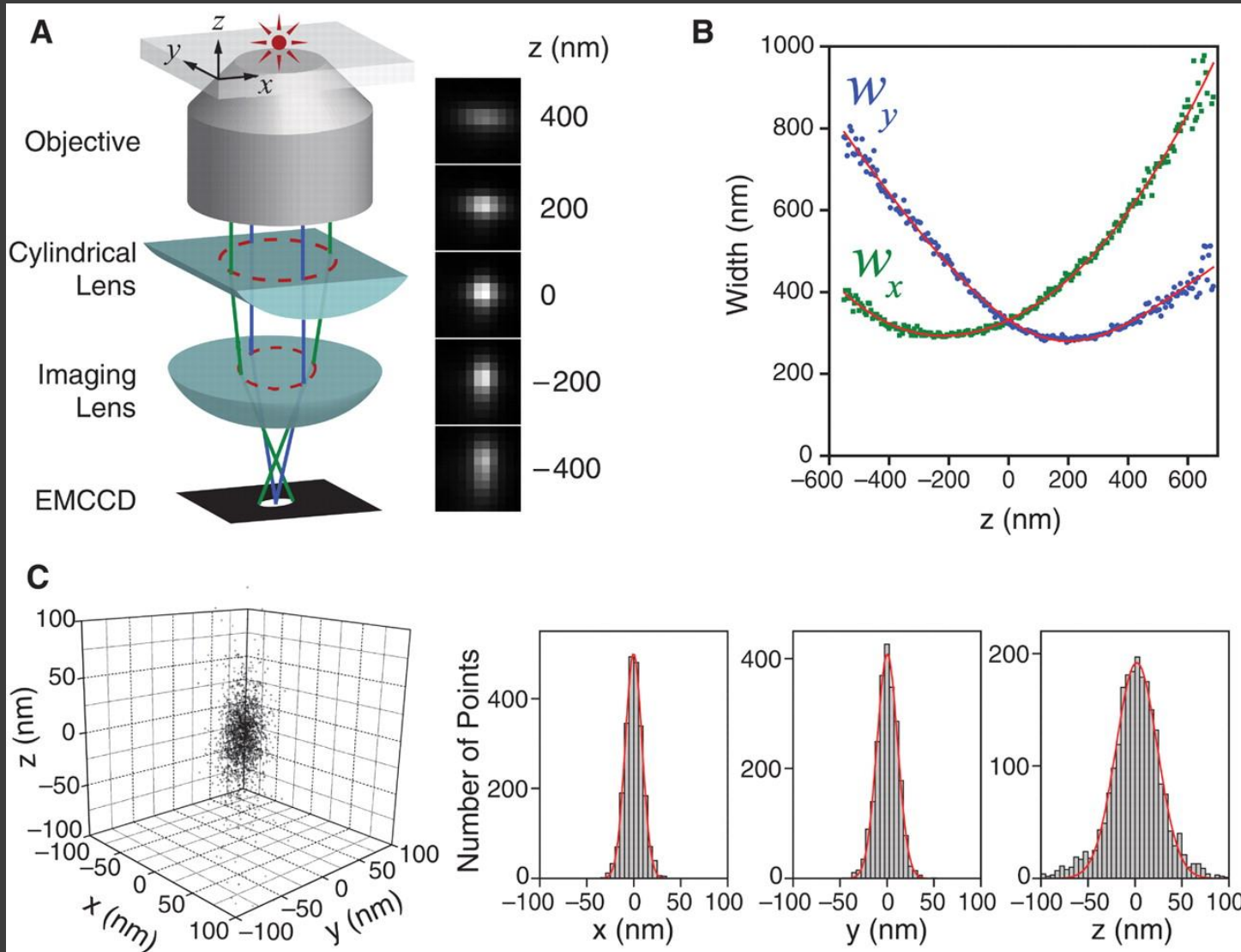

resolution
lateral: 30 nm
axial: 50 nm

Alexa405-Cy5-mitochondria

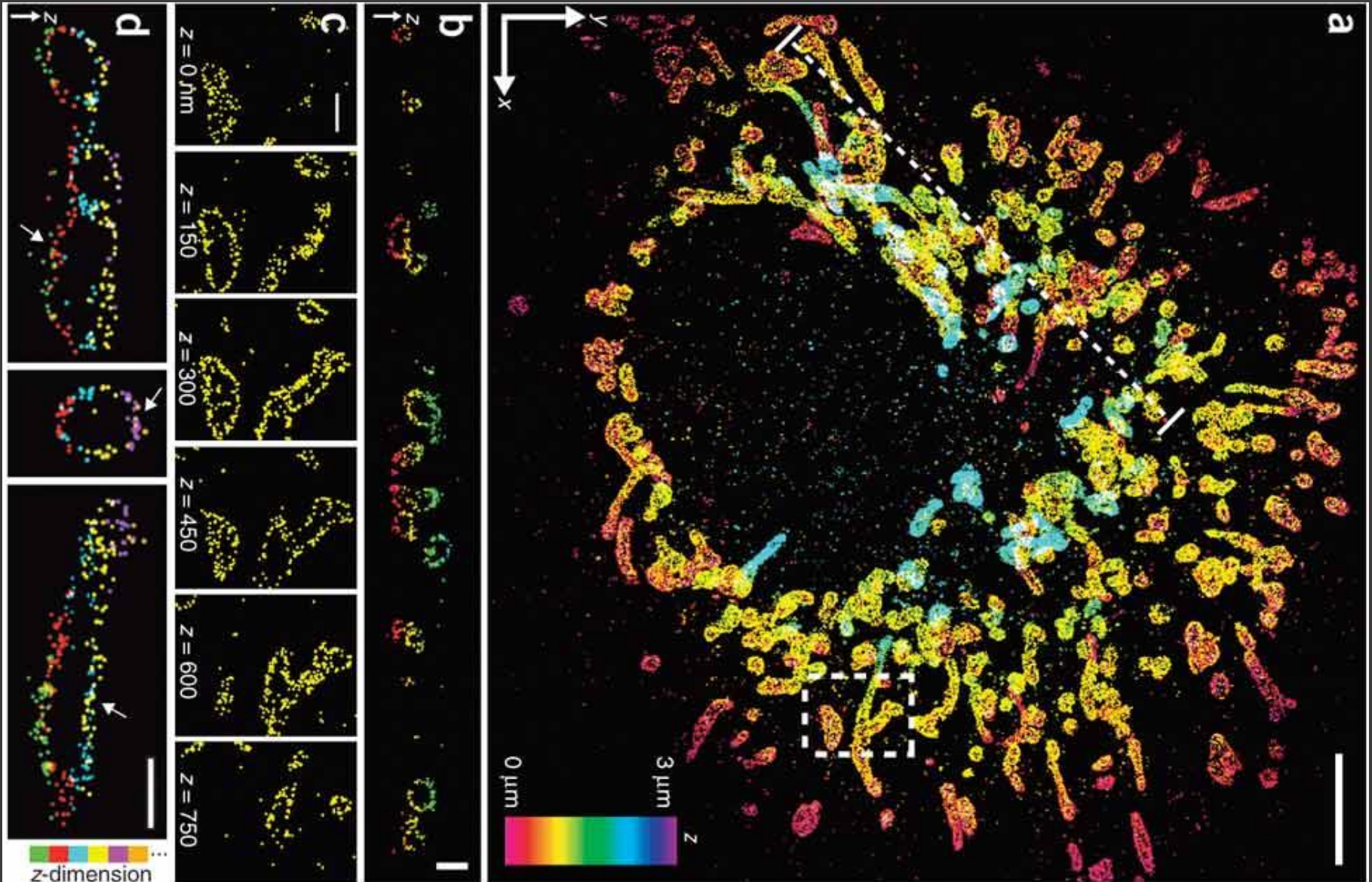

imaging of two different axial plane simultaneously

→ fitting of 3D-PSF yields 3D position of the fluorophore

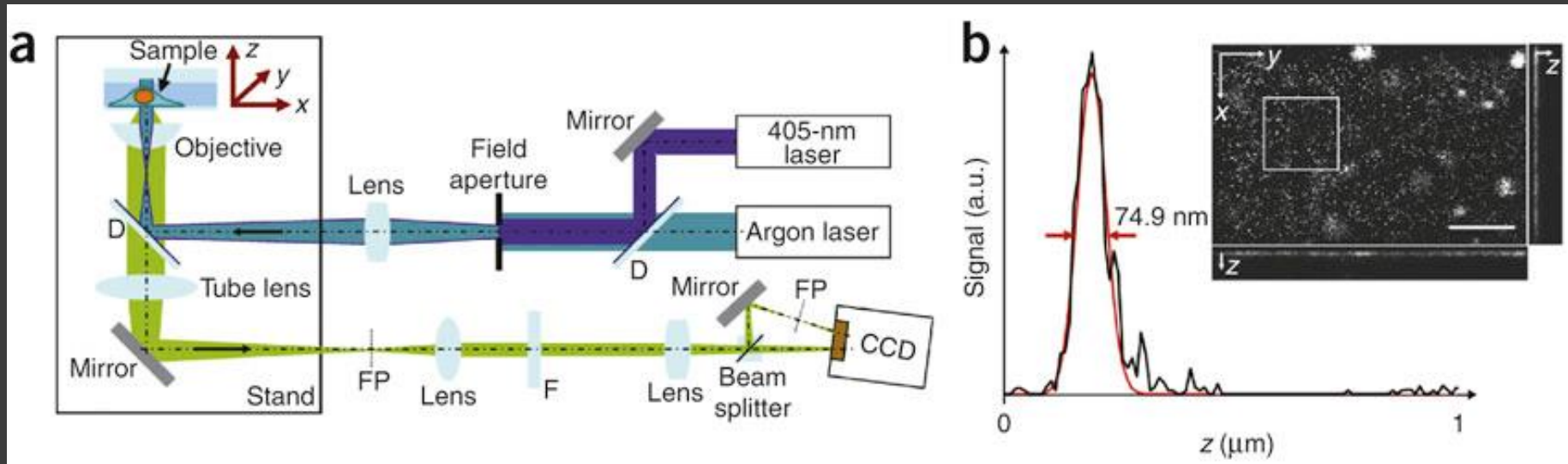

Juette et al., Nature Methods, 2008

resolution

lateral: 30 nm

axial: 60 nm

mtEos2-mitochondria

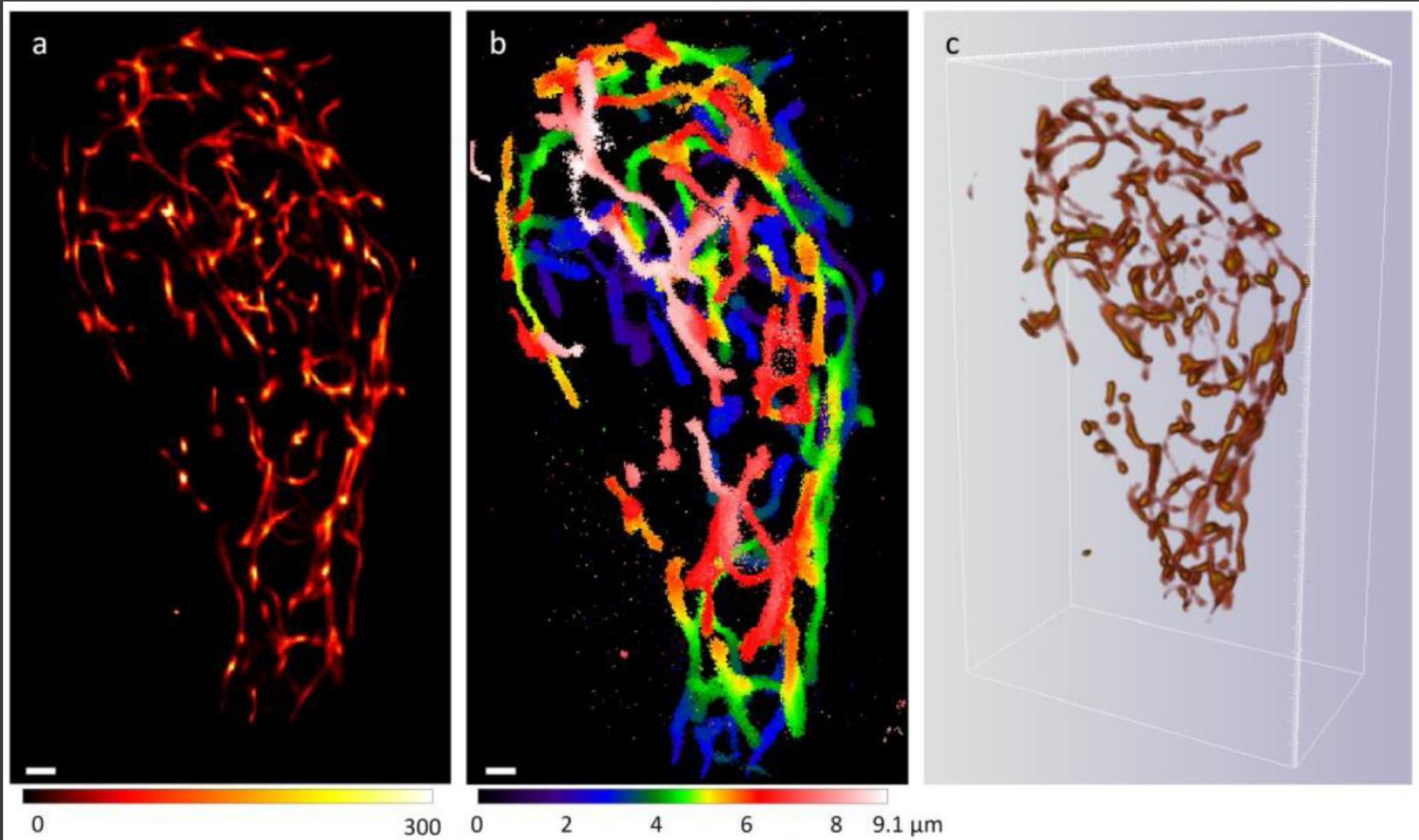

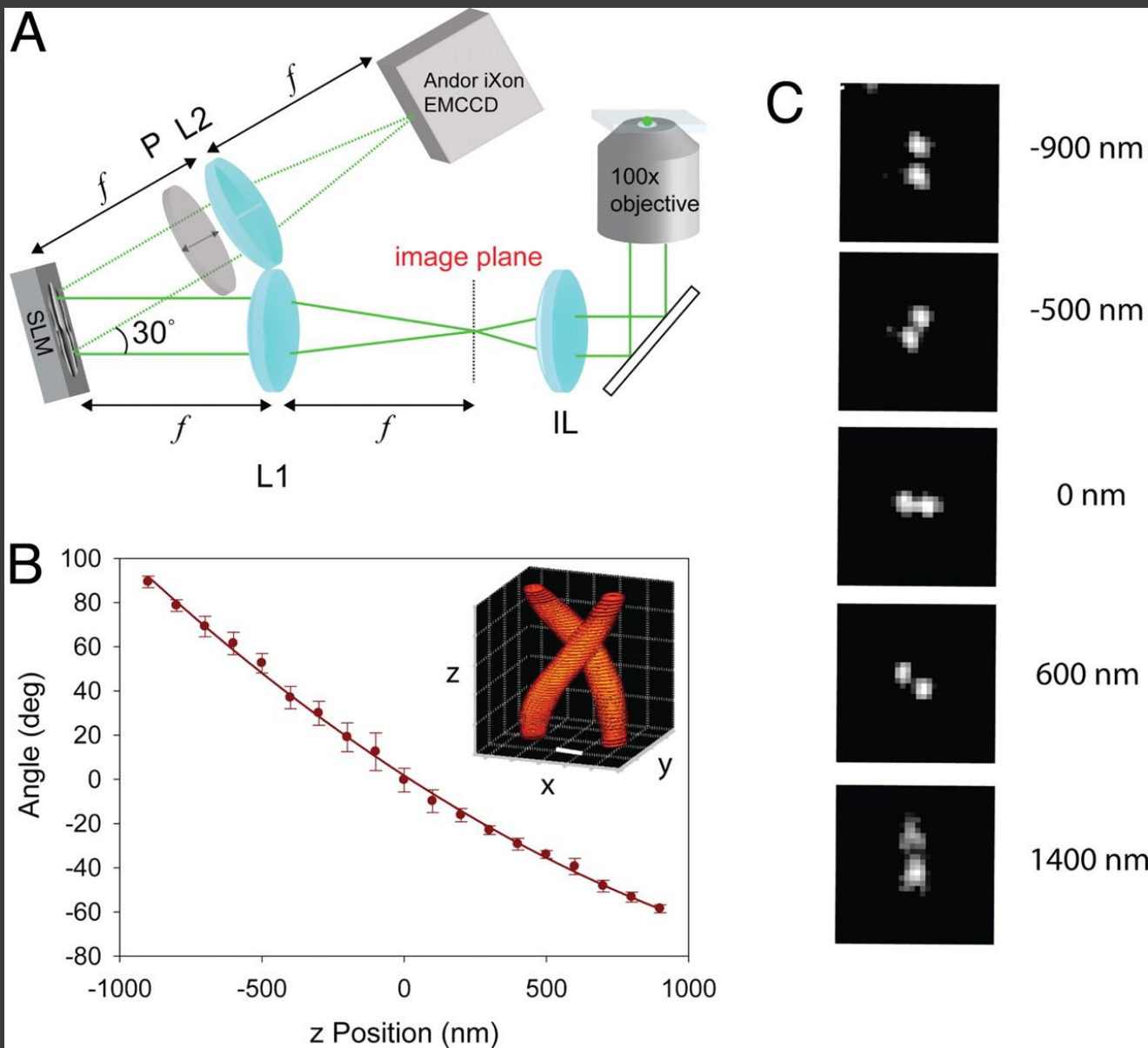

3D

double helical PSF

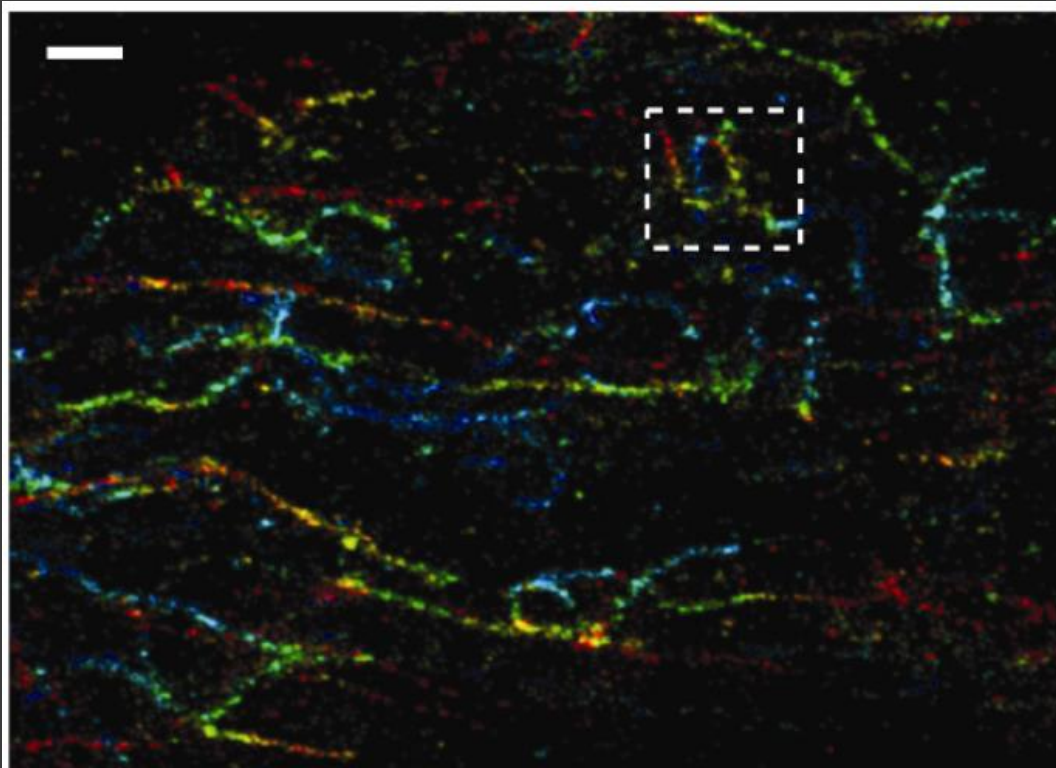

(a)

resolution
xy: 30 nm
z: < 100 nm

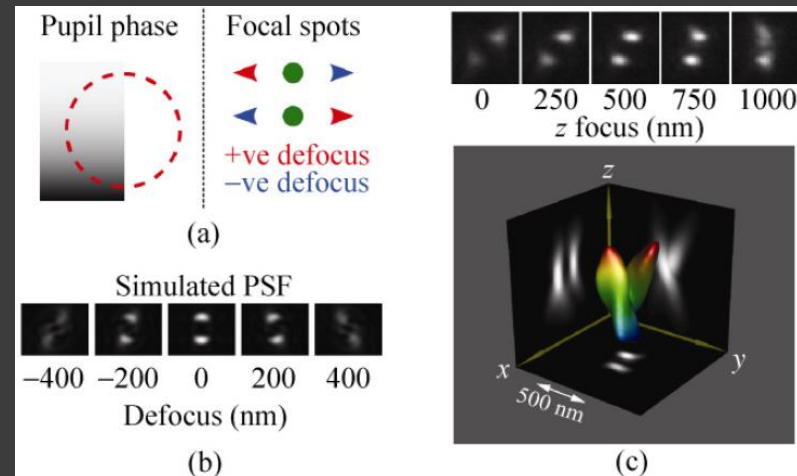
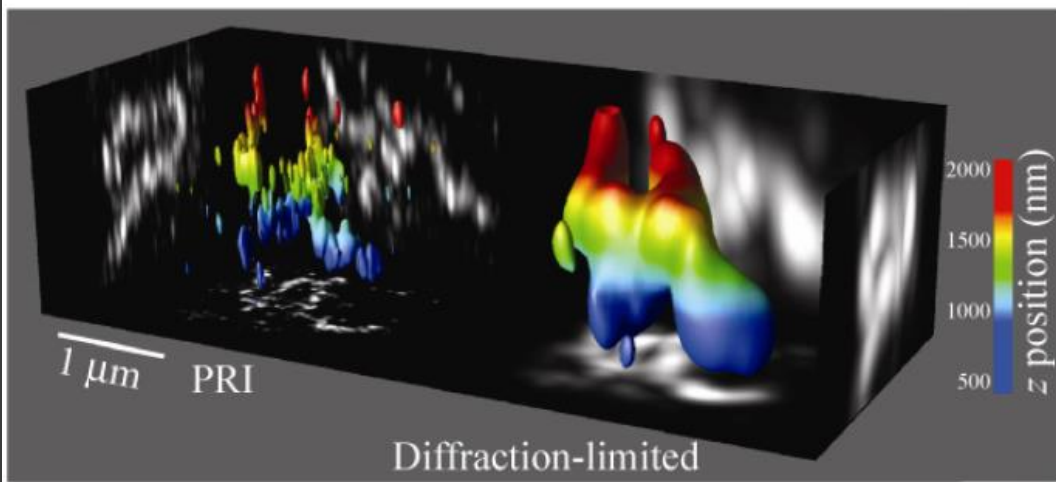

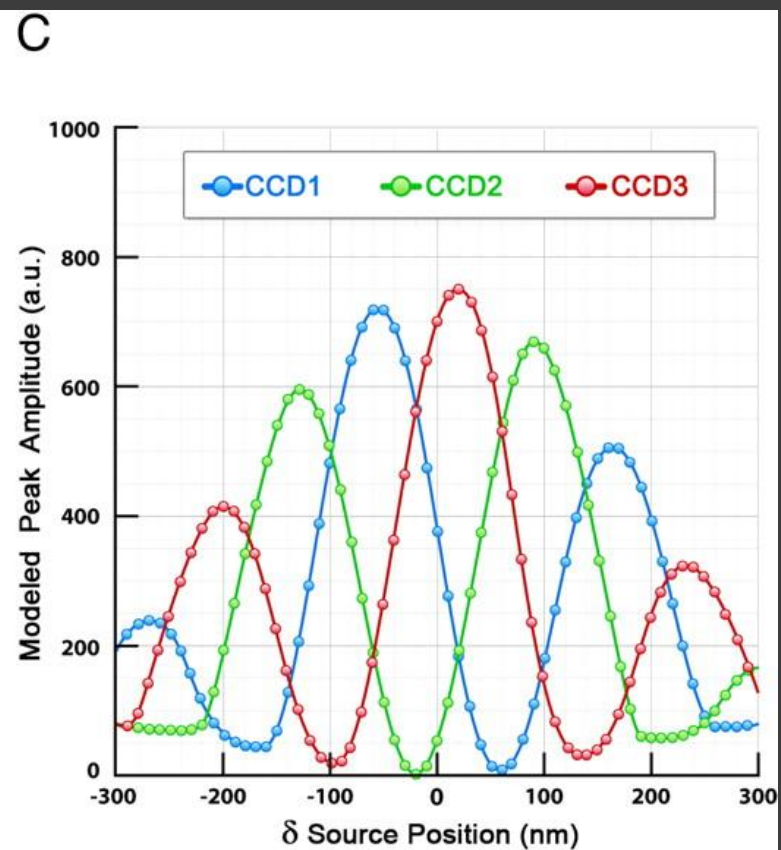
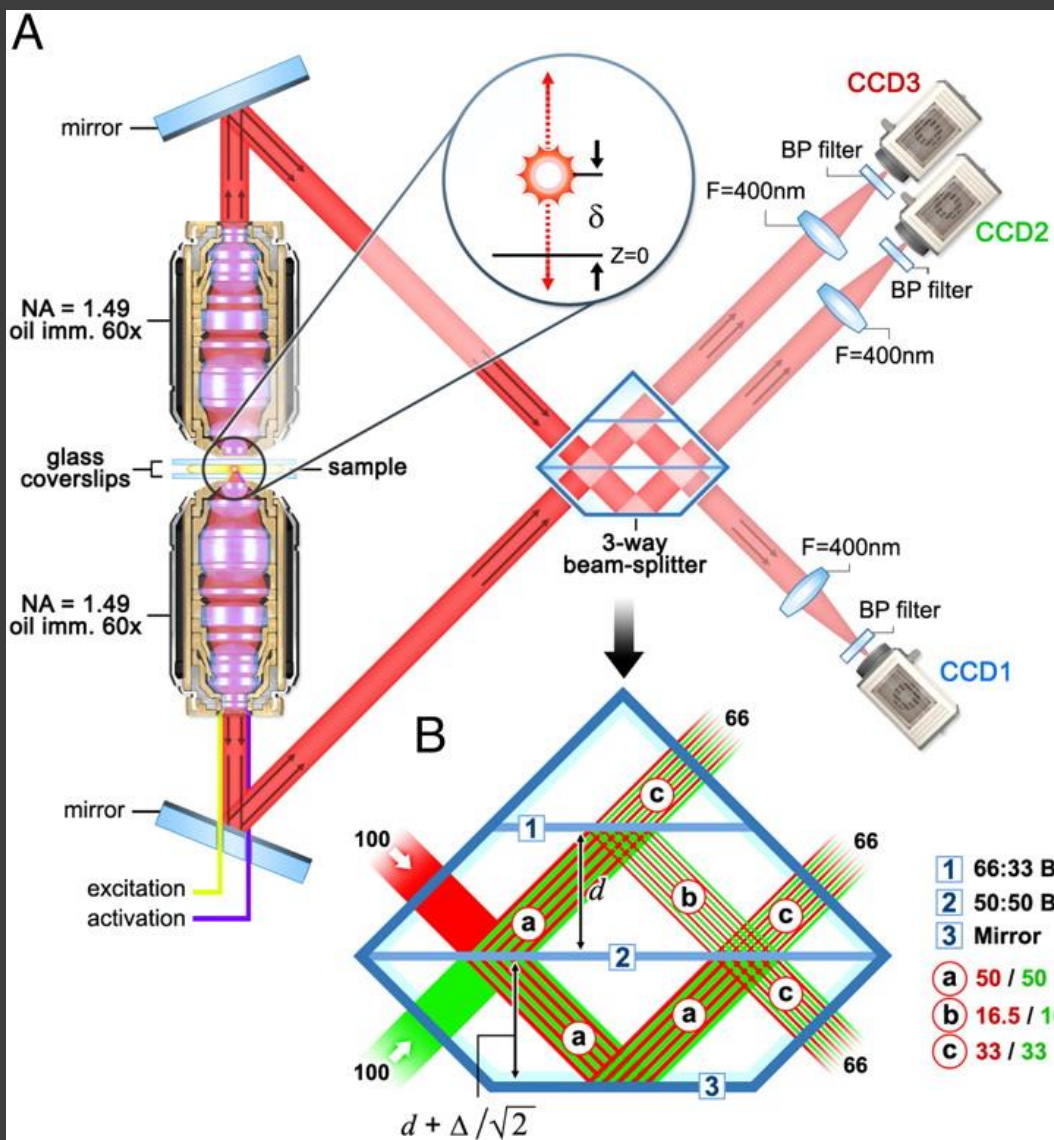

Mach-Zehnder-Interferometer

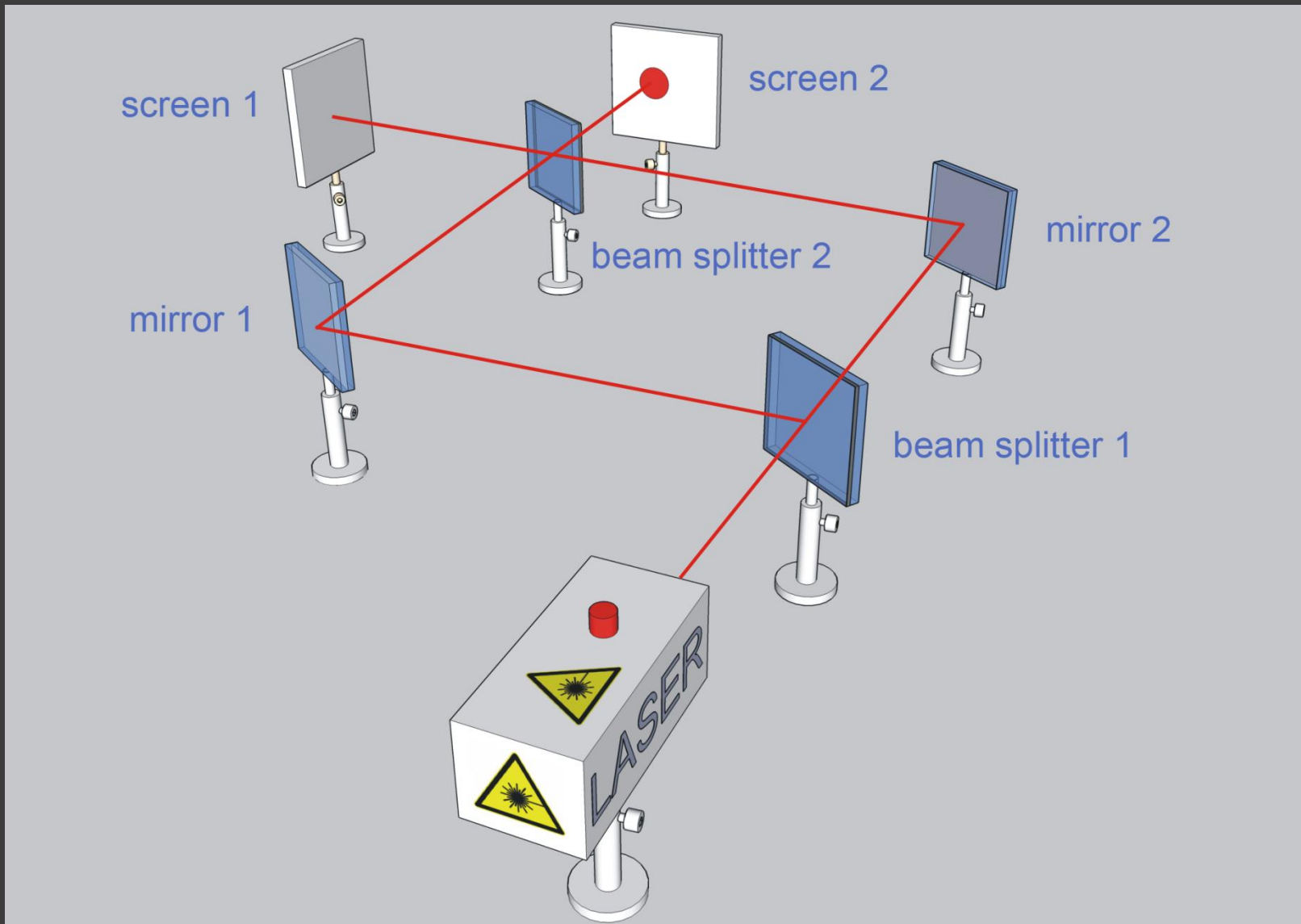

Single Photon Fluorescence Interference Microscopy (iPALM)

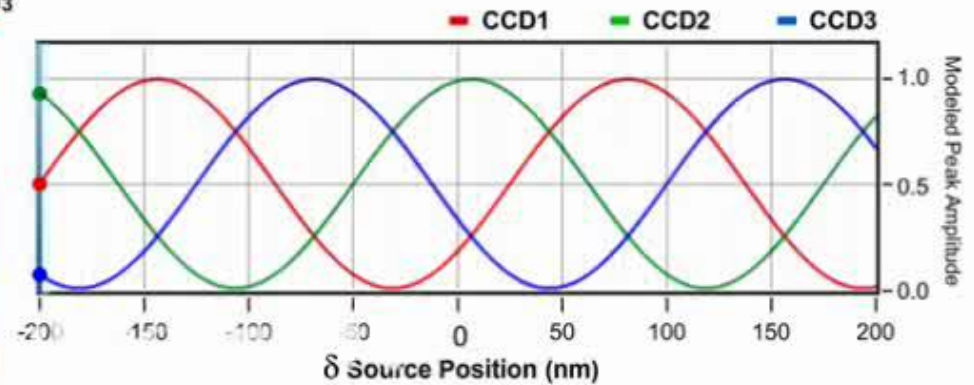
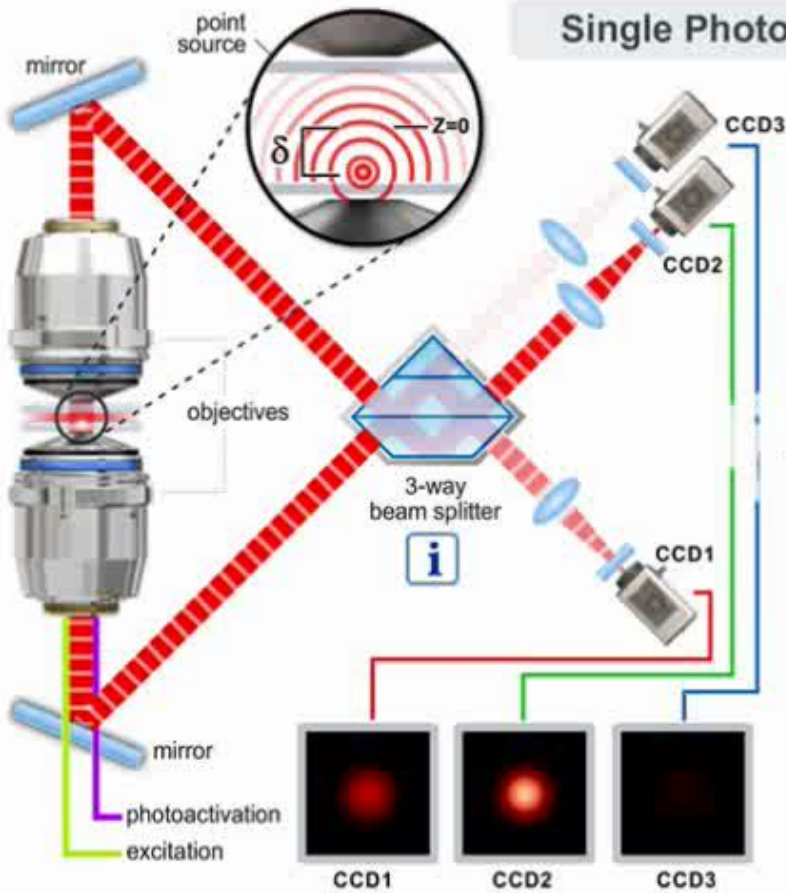

Modeled Peak Amplitude (a.u.)			Sample
CCD1	CCD2	CCD3	Z Position
0.5000	0.933	0.067	Z = -200 nm



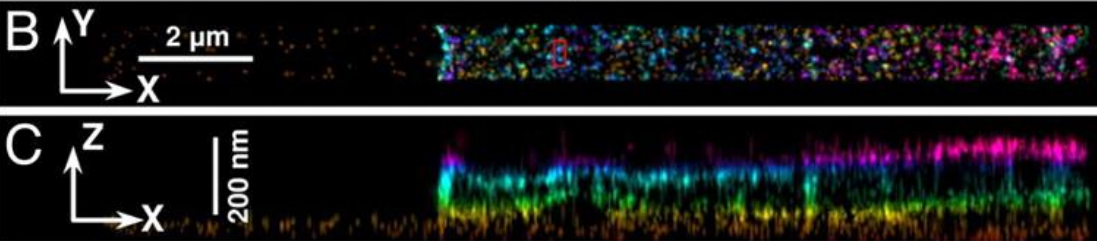
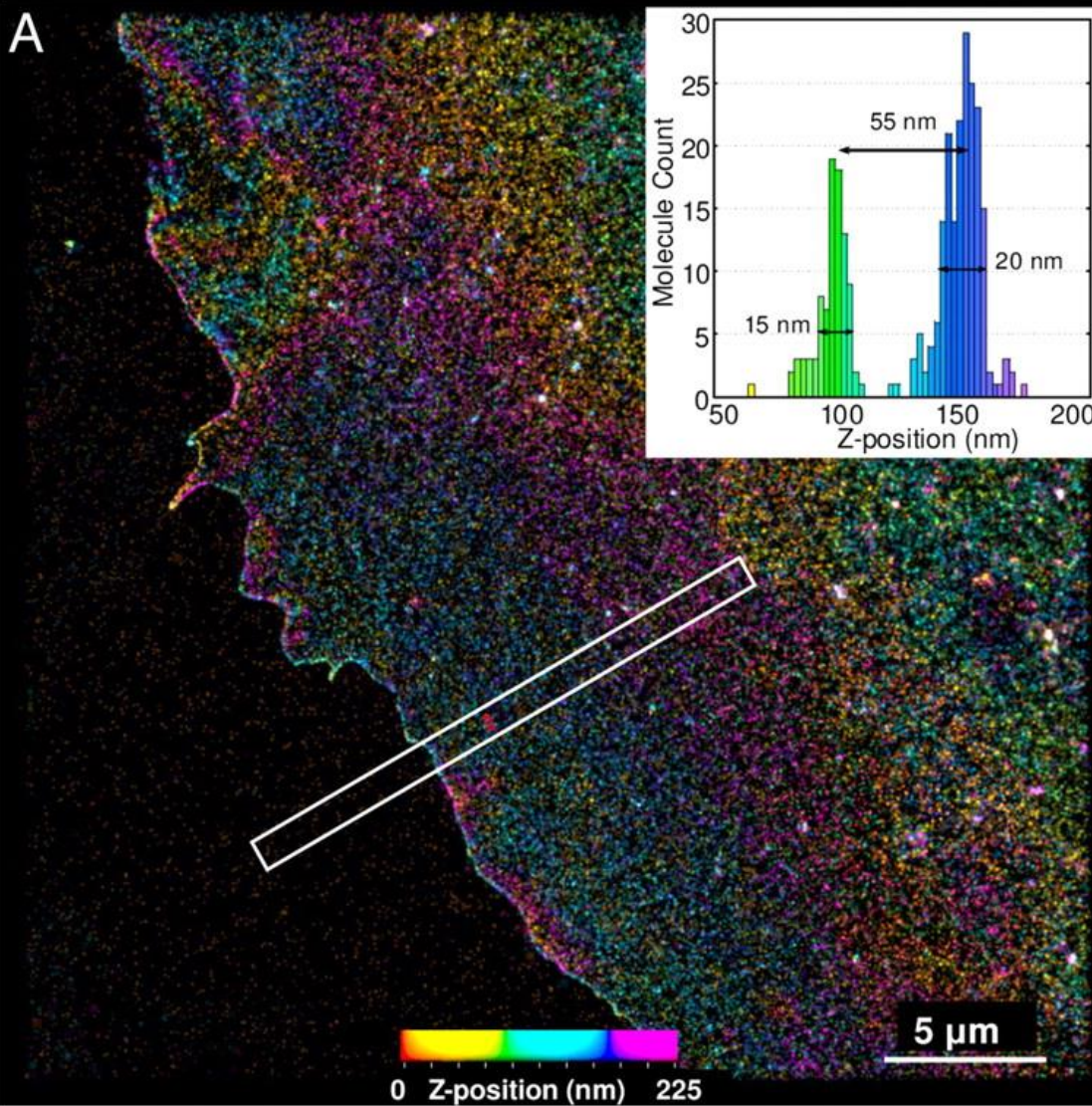

3D

4Pi-SMS

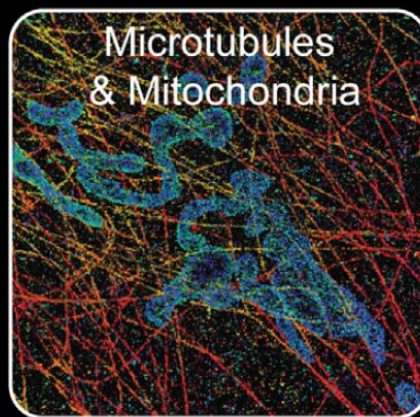
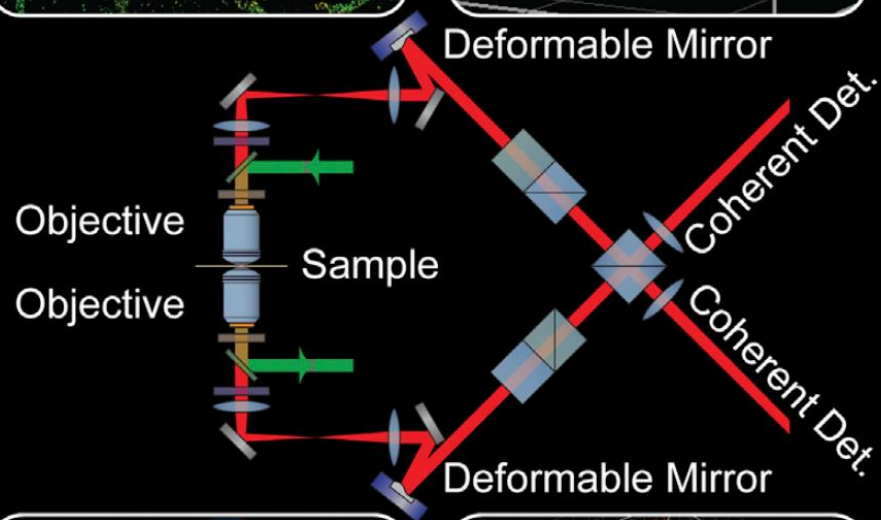
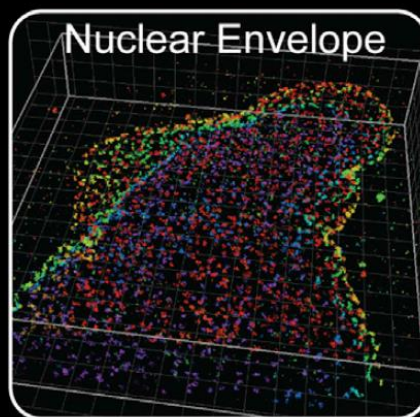
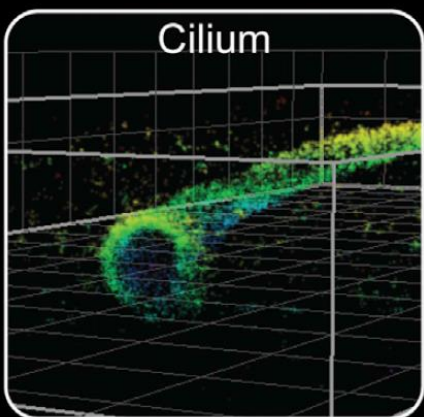
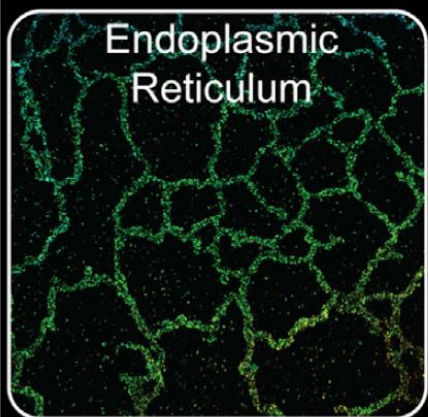

whole cell 3D imaging
with 10-20 nm resolution

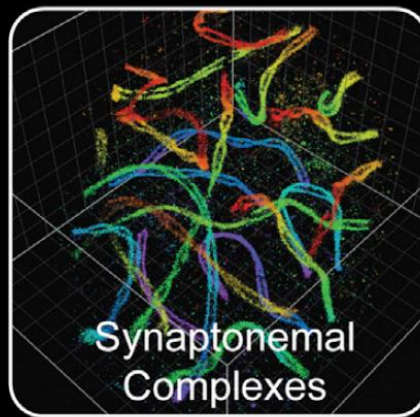
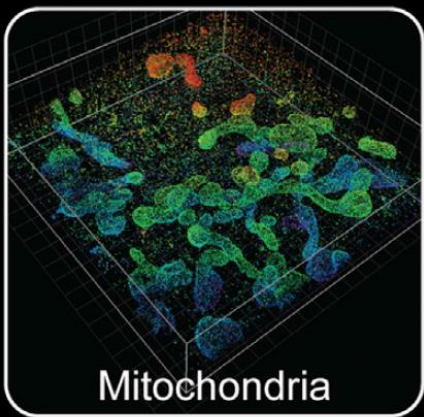
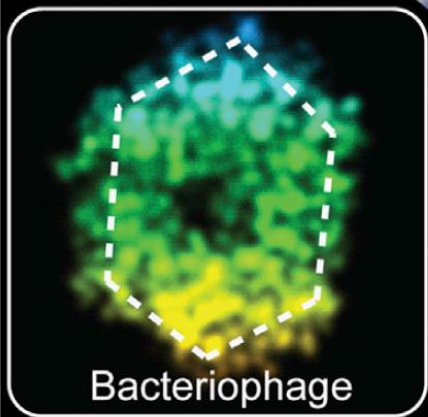

two examples for “live-cell” applications

live-cell STORM (dSTORM)

resolution

2D

spatial: 25 nm

temporal: 500 ms

3D

spatial: xy: 30 nm, z: 50 nm

temporal: 1-2 s

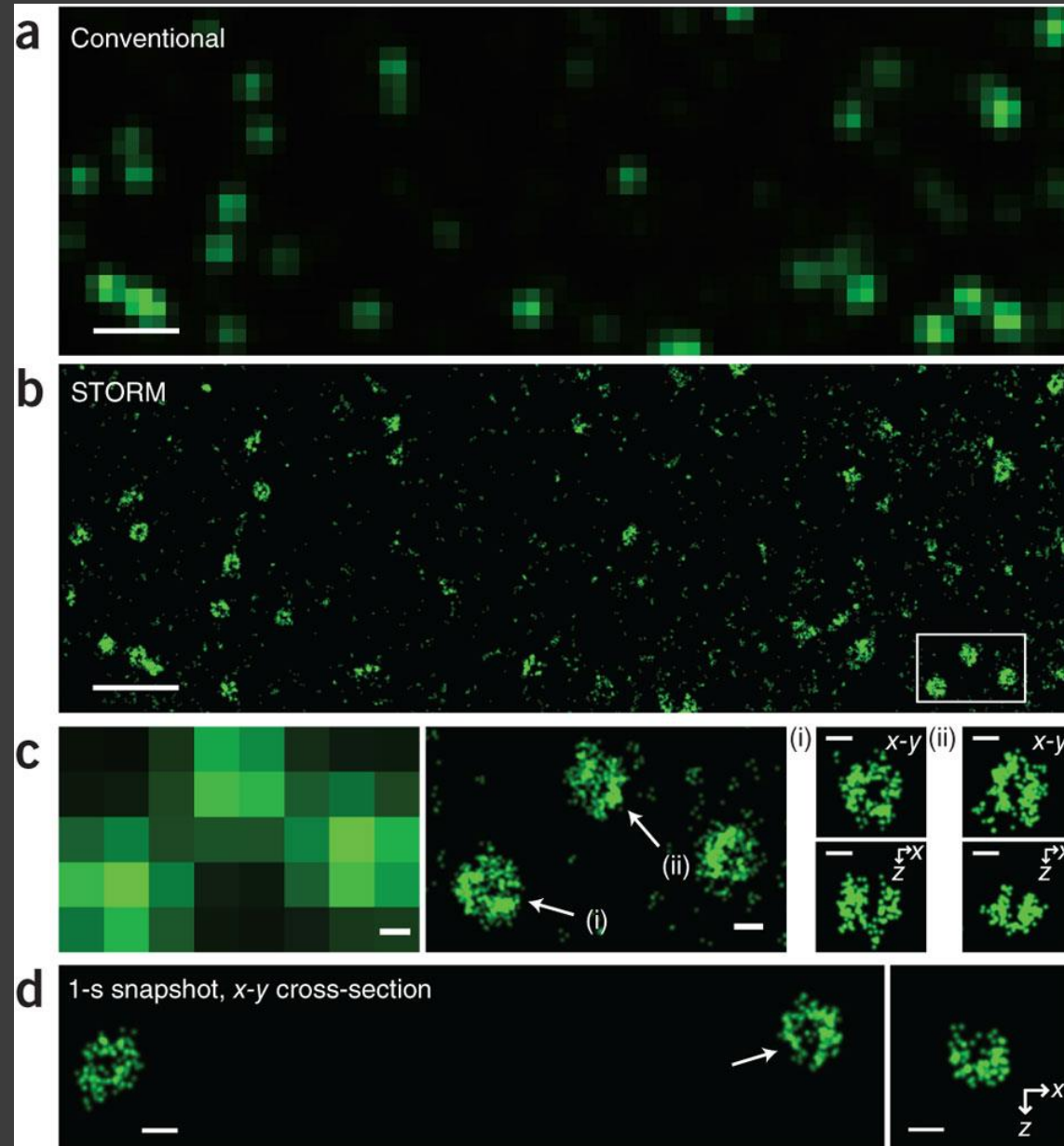

Alexa647-CCP

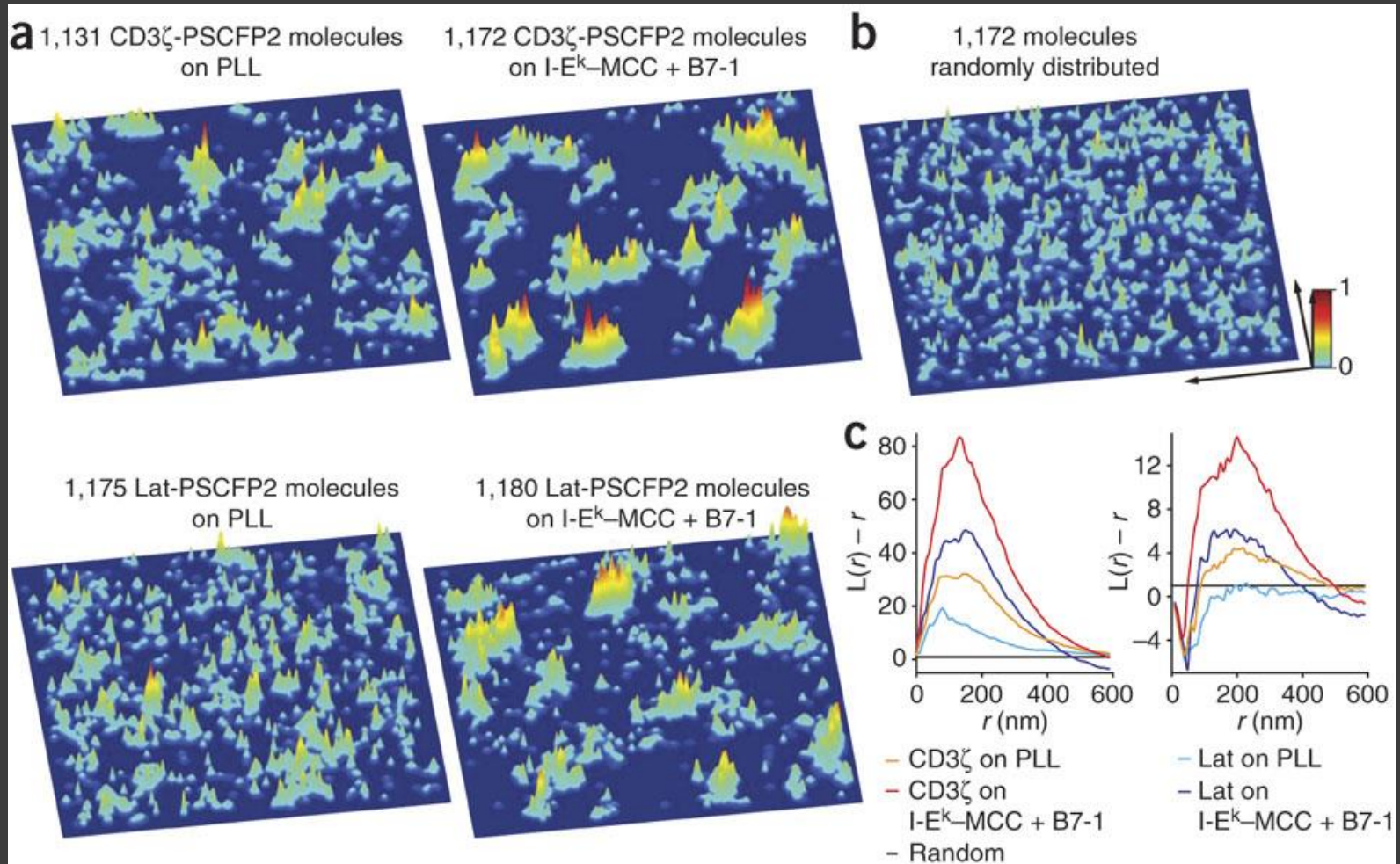

Lillemeier et al., Nature Immunology, 2009

2D, spatial resolution: 60 nm, temporal resolution: 4-10 s

how to get a lot more information from the data

the additional single molecule information

remember?

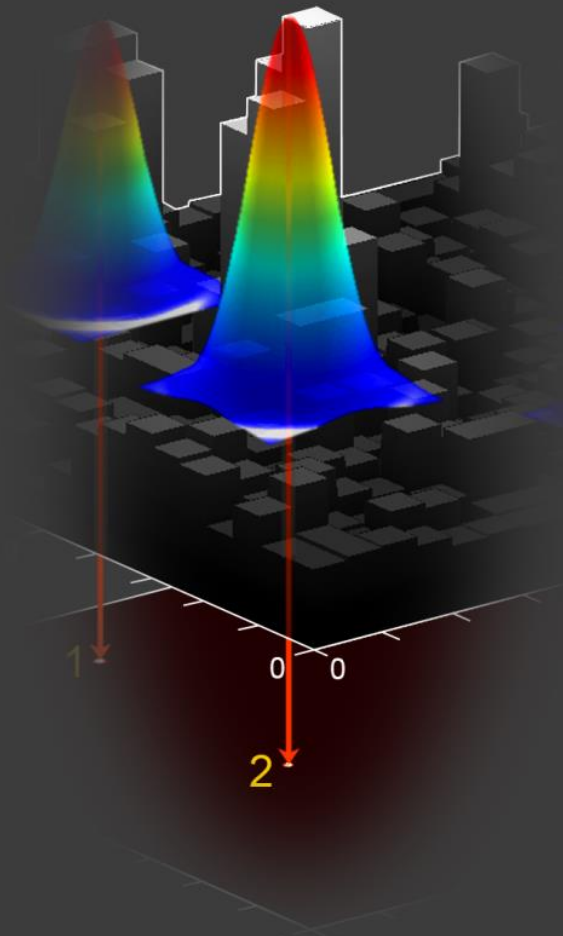

all the molecules in the image have been detected one by one

- position of each molecule
- number of detected photons
- shape of the PSF
- polarisation
- wavelength
- dynamics (in living cells)
- ...

statistical analysis of small protein clusters

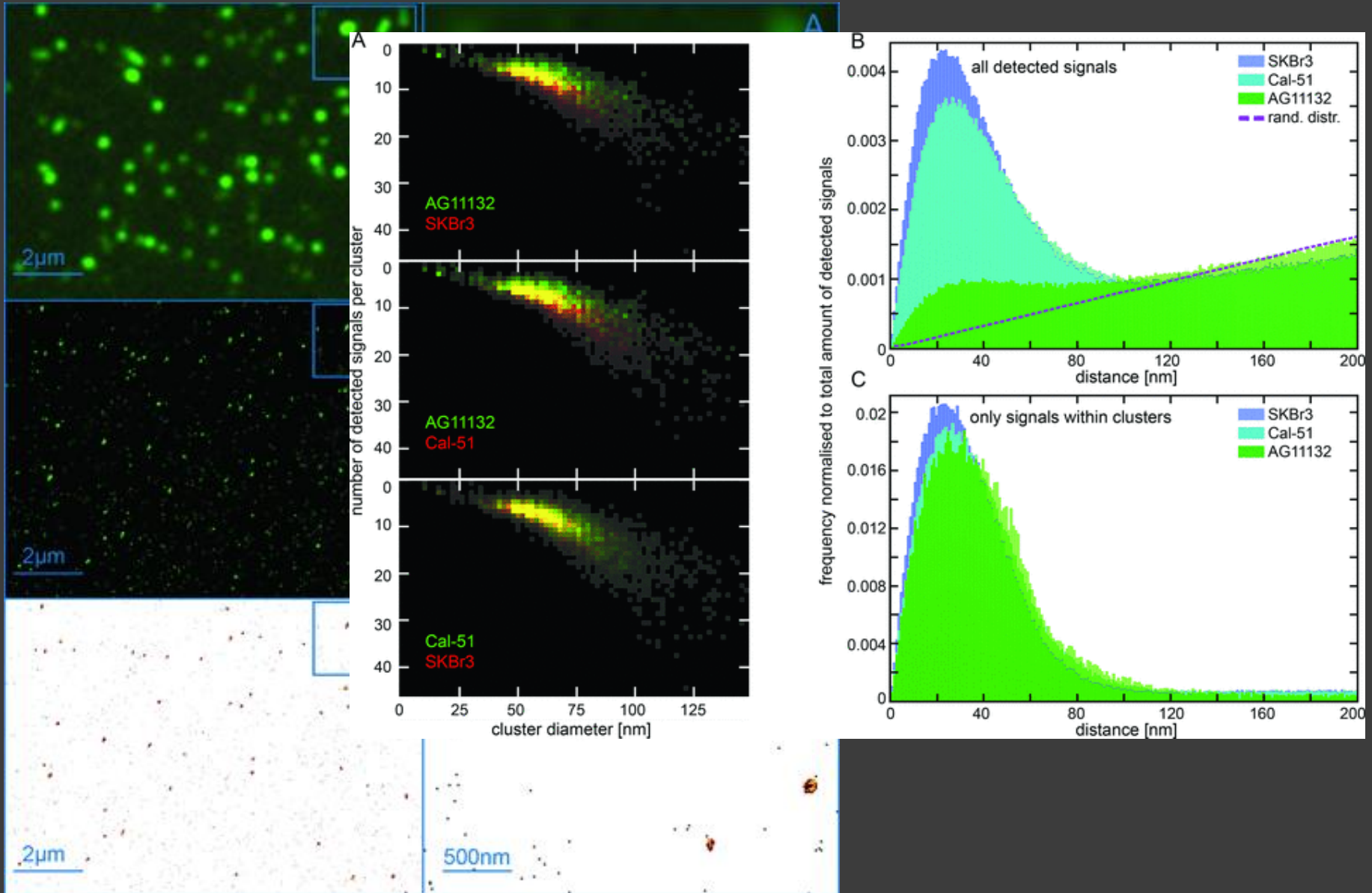

analysis of protein clusters and molecule counting

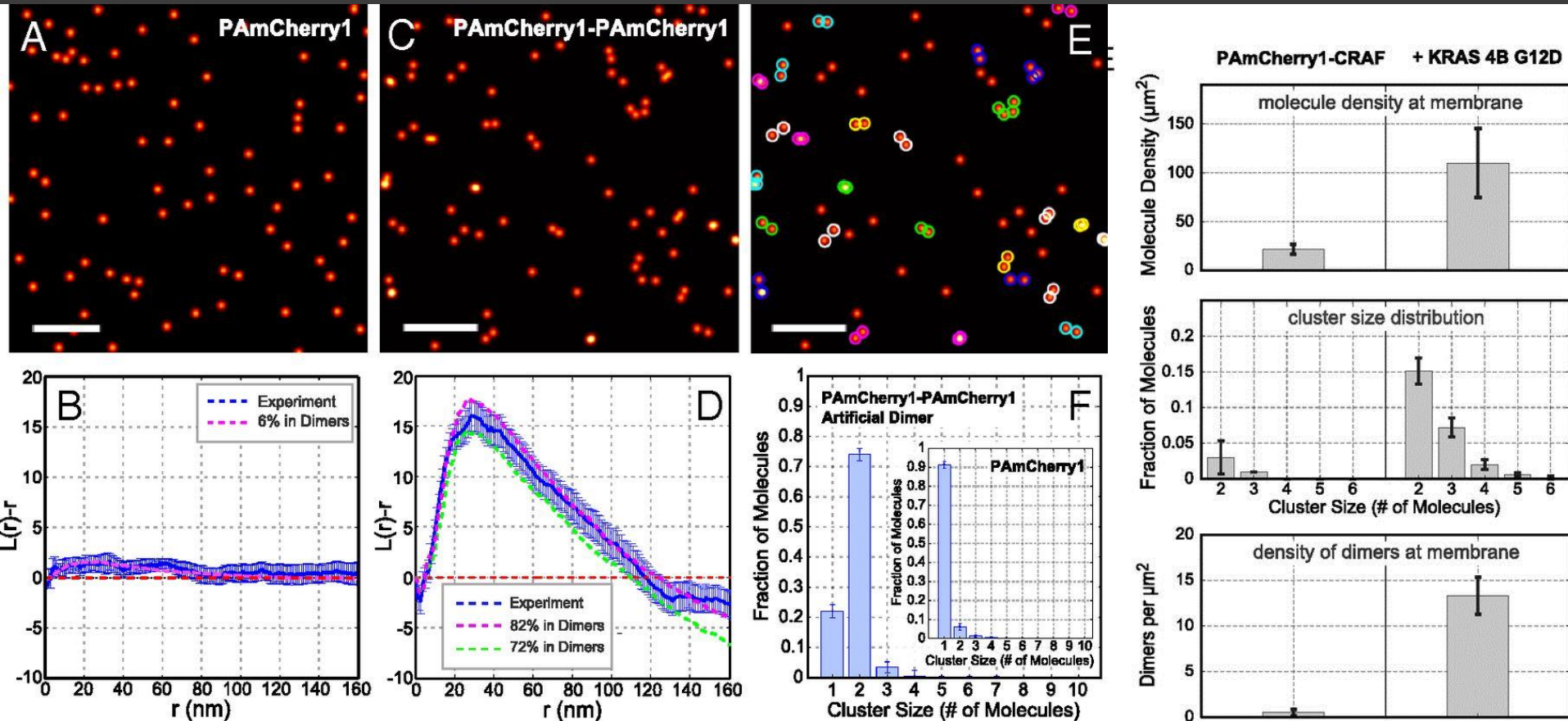

statistical analysis of large protein clusters

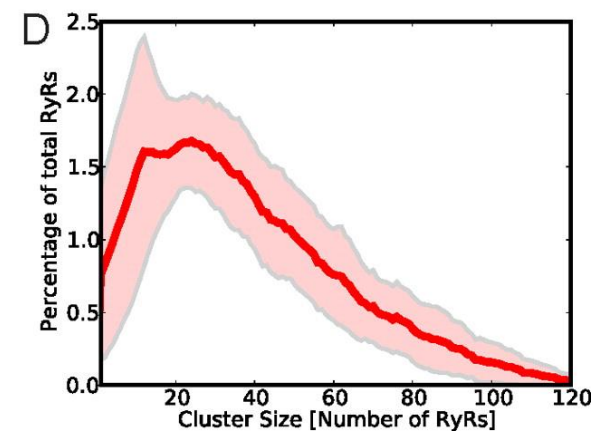
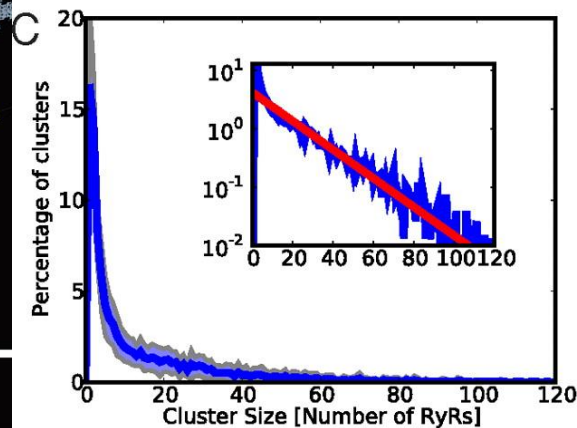
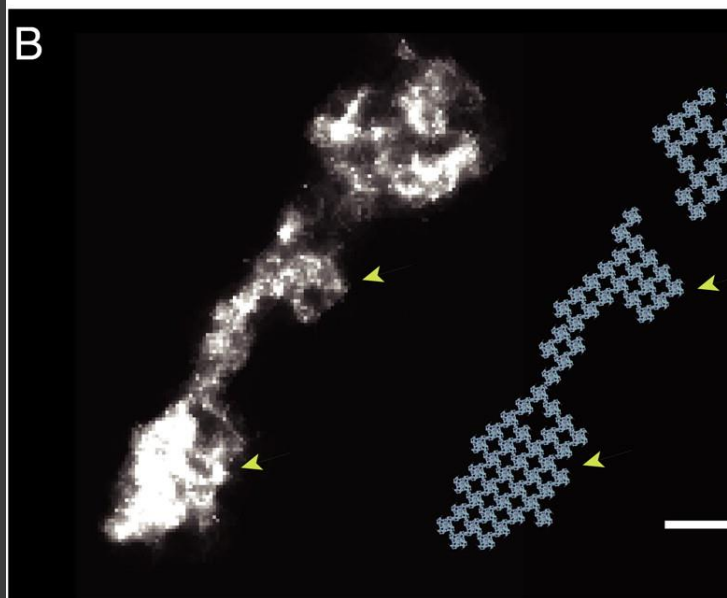
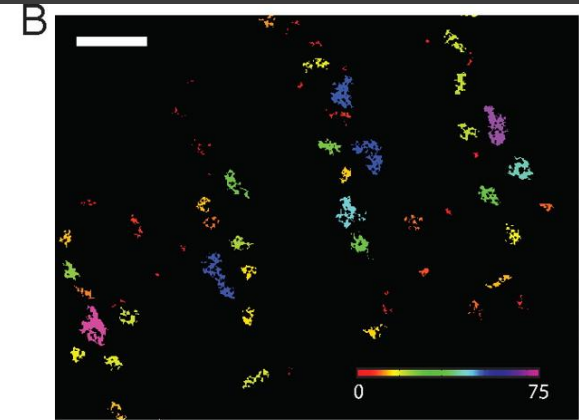
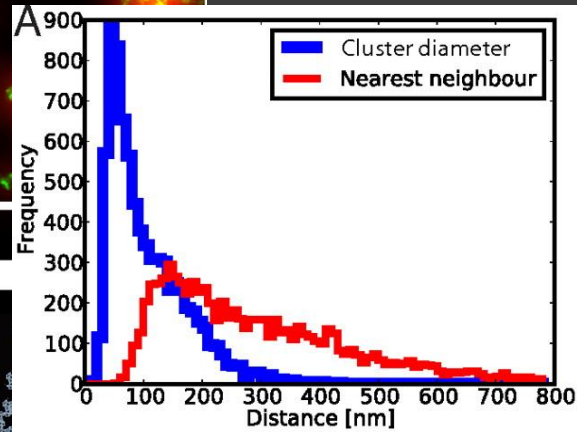
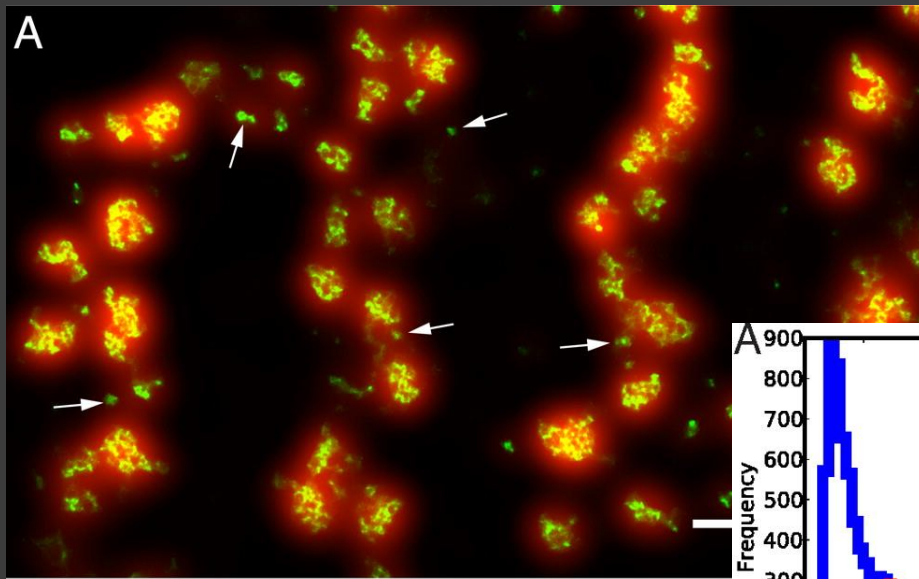

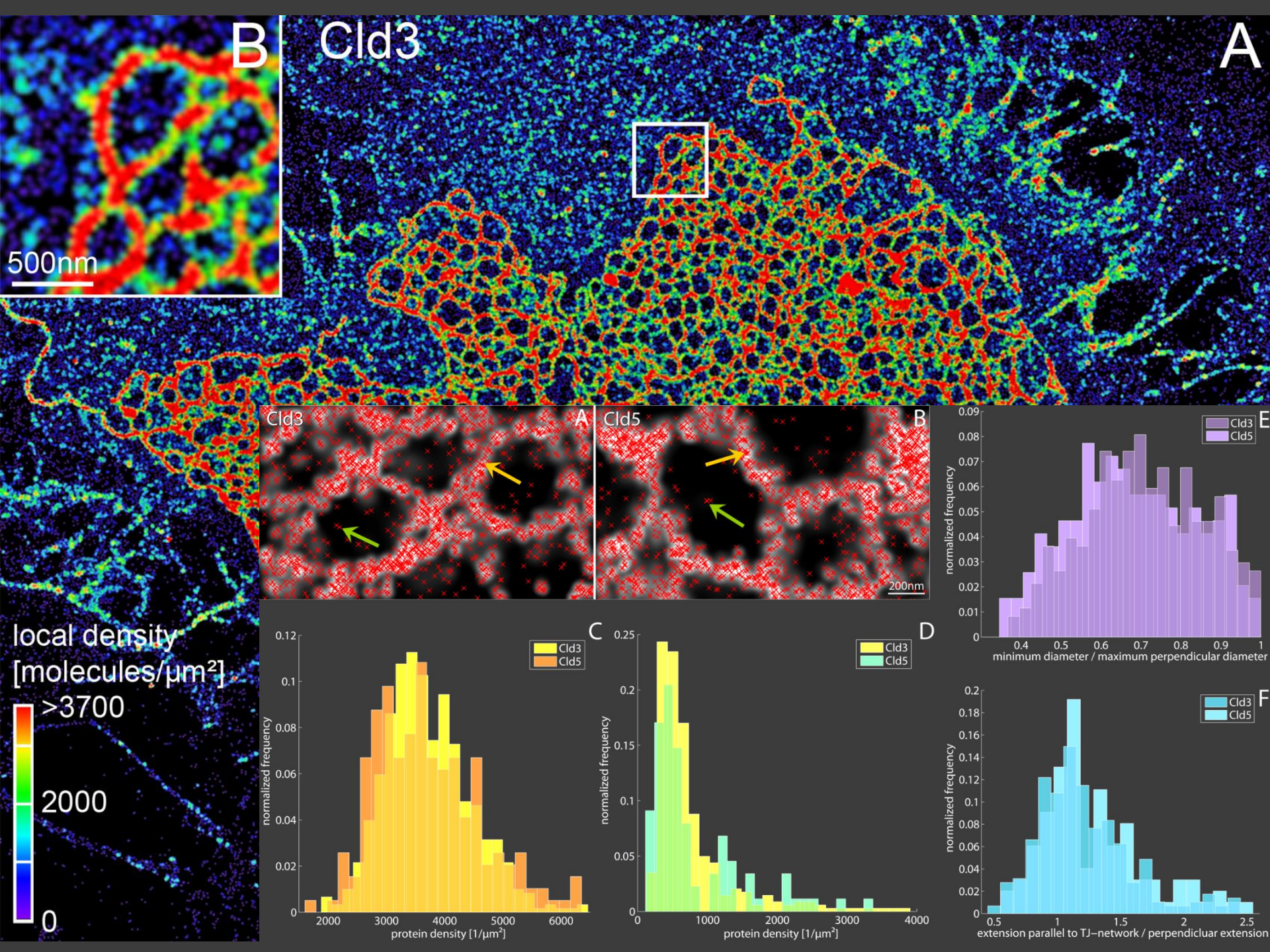

visualisation of protein densities

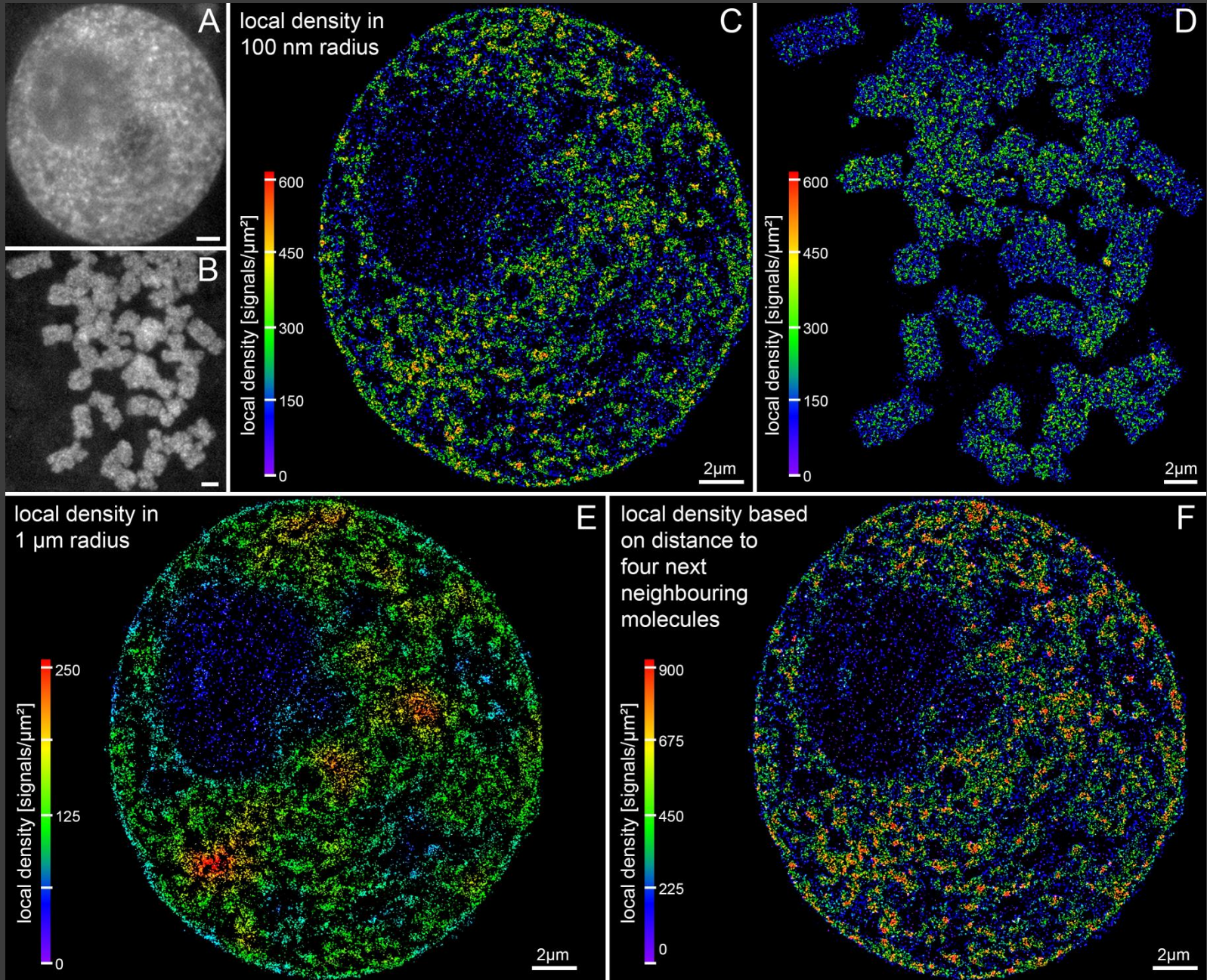

polarisation of the detected fluorophores

Dendra2-actin

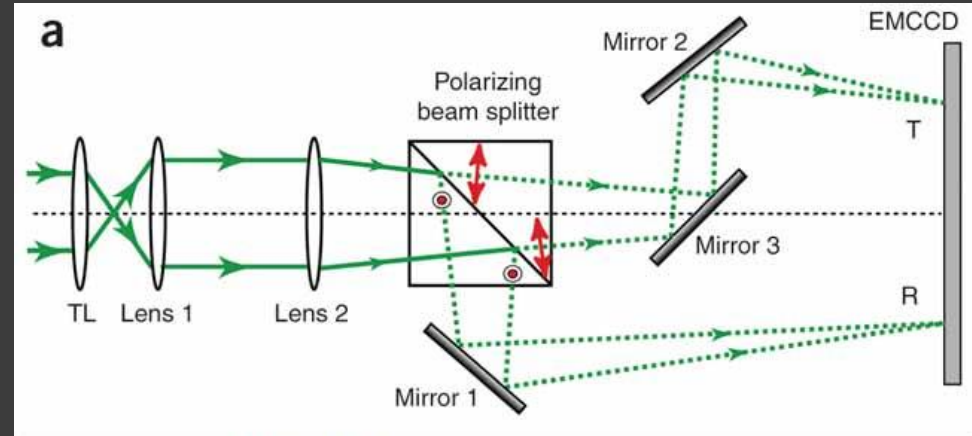
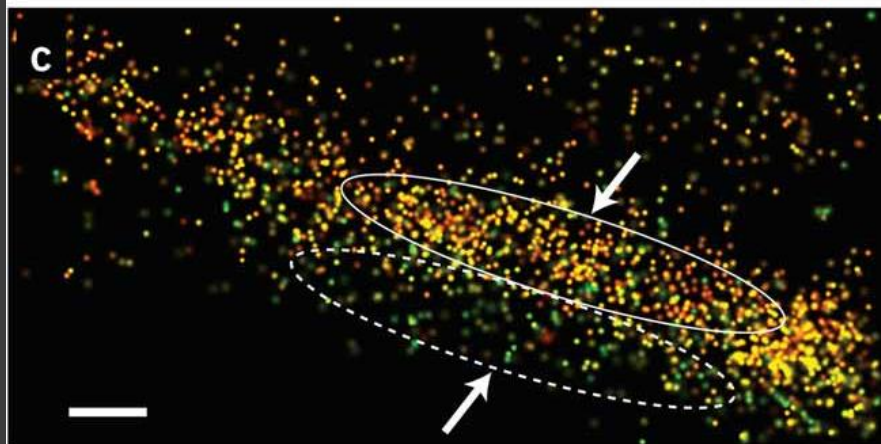
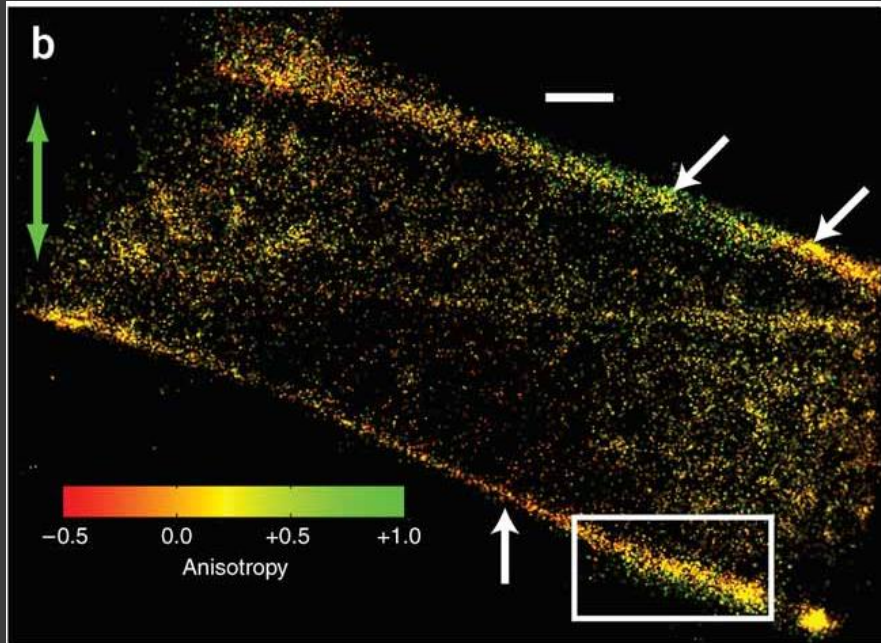

Gould et al., Nature Methods, 2008

high density particle tracking in living cells

sptPALM or uPAINT

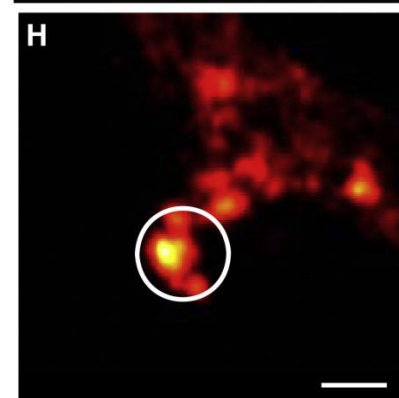
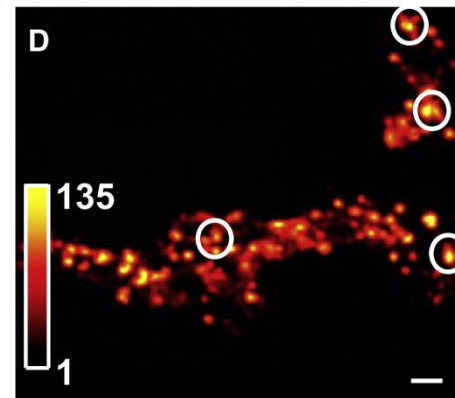
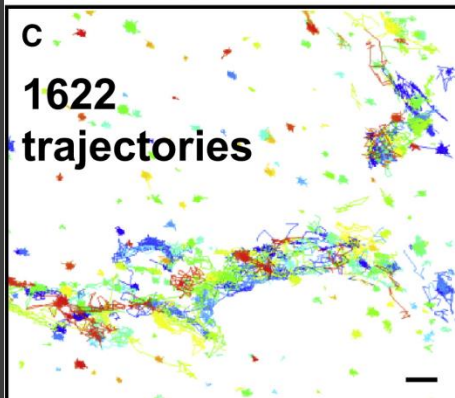
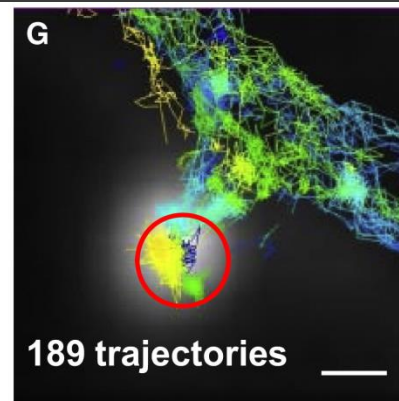
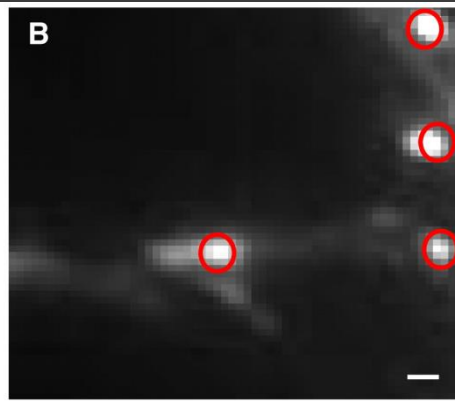
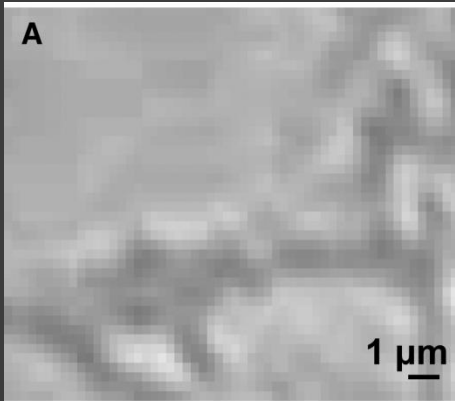

sptPALM:
Manely et al., Nature
Methods, 2008

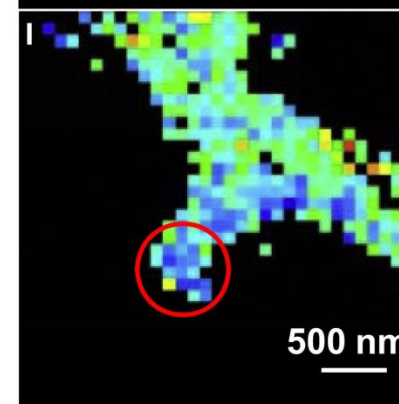
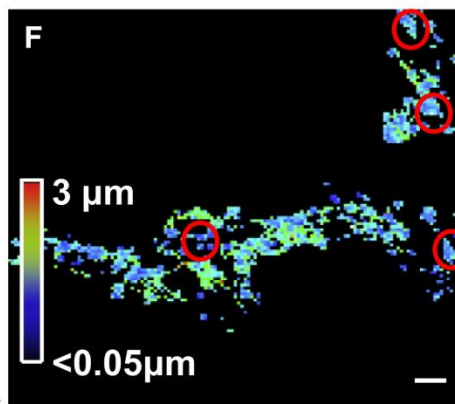
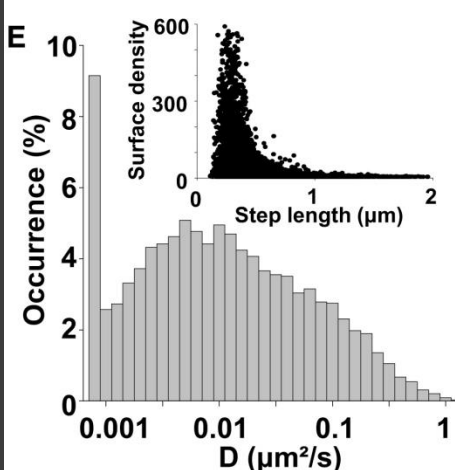

antiGluR2-AT647N-AMPA

alternative approaches

SOFI - making the setup even more simpler

localization microscopy using a lamp!

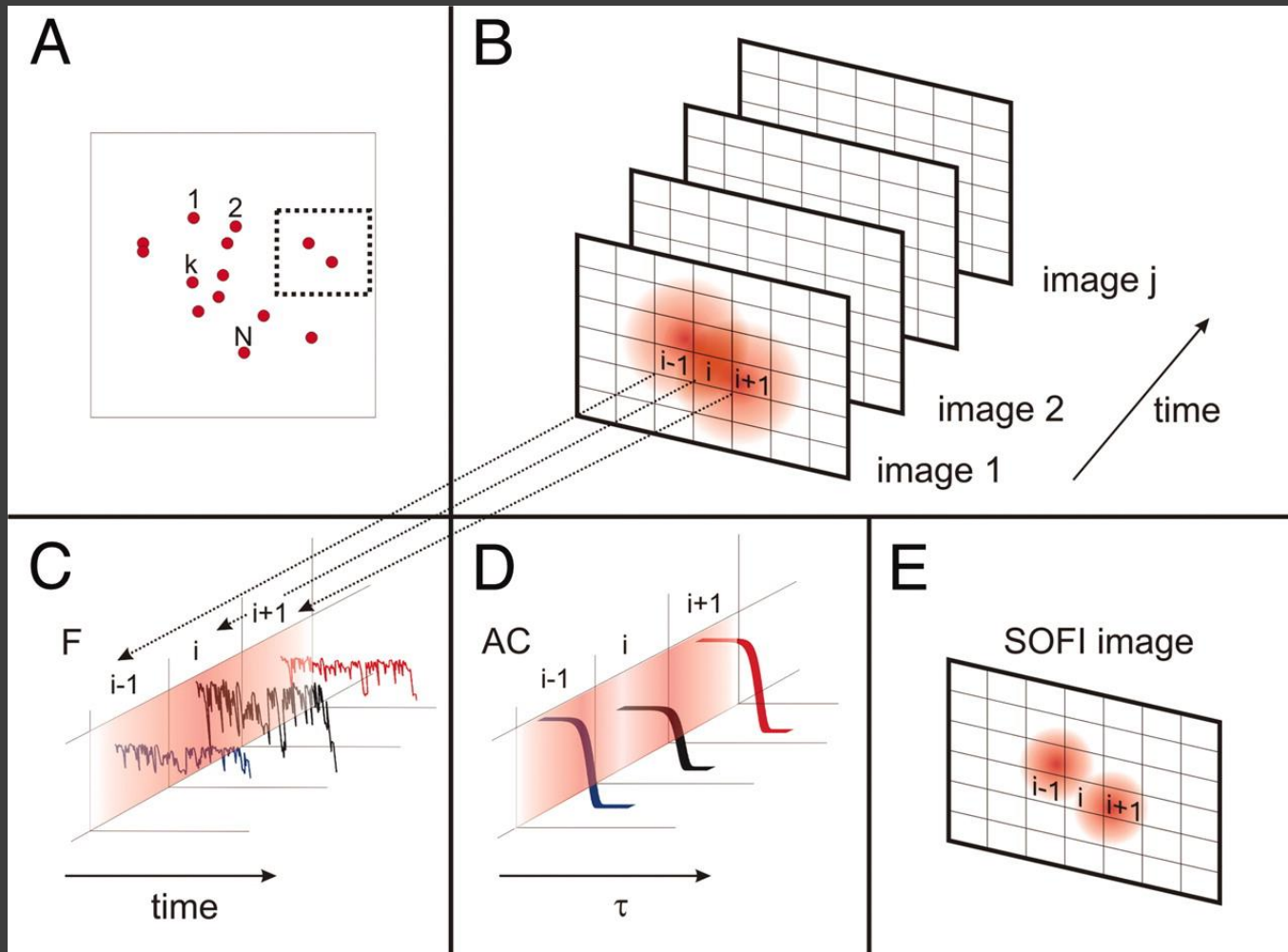

Dertinger et al., PNAS, 2009

$$\sum_{k=1}^N U(\mathbf{r} - \mathbf{r}_k) \cdot \boldsymbol{\varepsilon}_k \cdot s_k(t)$$

$$G_2(\mathbf{r}, \tau) = \sum_k U^2(\mathbf{r} - \mathbf{r}_k) \cdot \boldsymbol{\varepsilon}_k^2 \cdot \langle \delta s_k(t + \tau) s_k(t) \rangle$$

SOFI - making the setup even more simpler

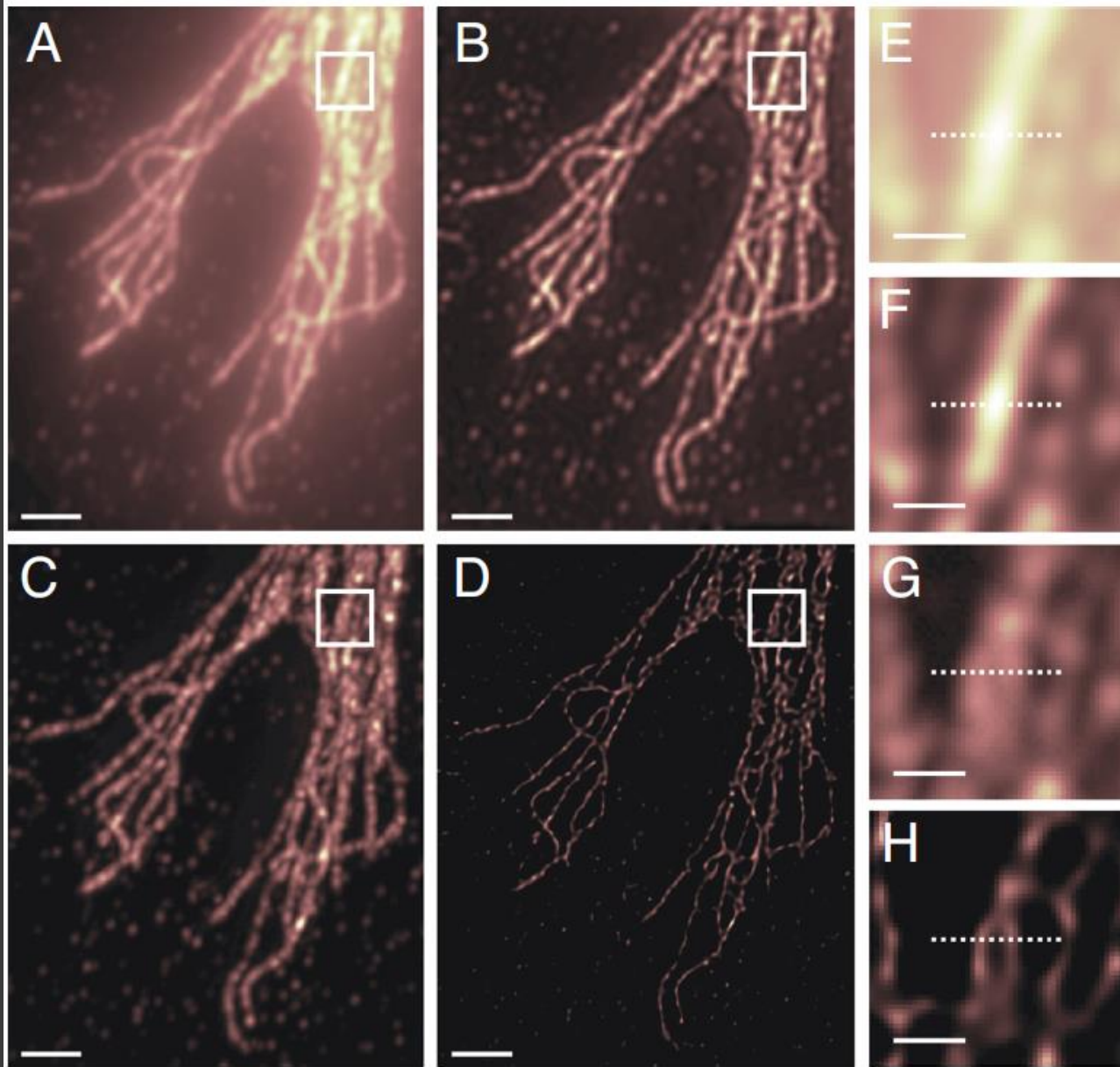

lateral resolution:
70-100 nm

BUT!

no single molecule
information

only resolution
enhancement

3B analysis localization microscopy

similar approach as SOFI but some differences:

+ also based on very high molecule densities fluorescent in one frame

→ very fast: only several hundred frames needed for reconstruction of an image
with a resolution of 50 nm → time resolution: 4 s

- extremely extensive computation effort

→ regions larger than $2 \times 2 \mu\text{m}$ would need to be processed for days on a
conventional (core i7) CPU

3B analysis localization microscopy

wide-field

reconstruction (resolution: 50 nm)

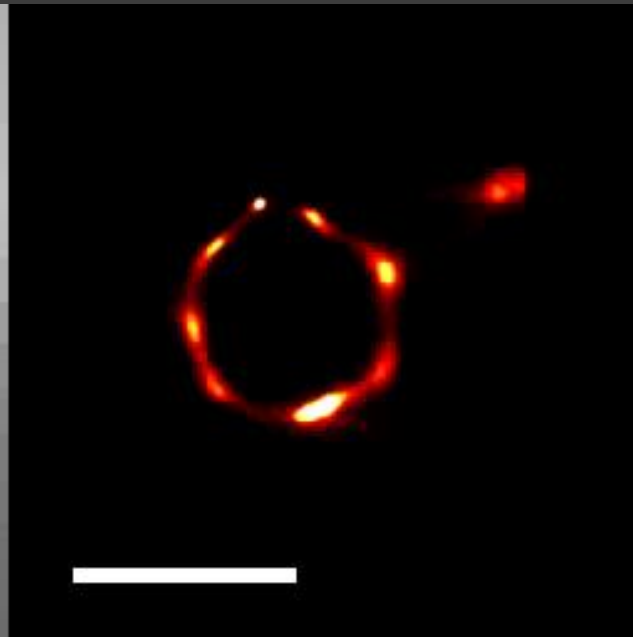
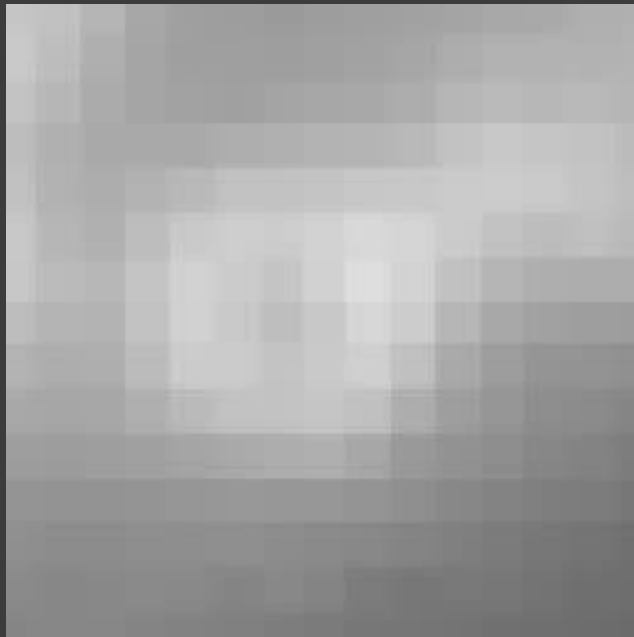
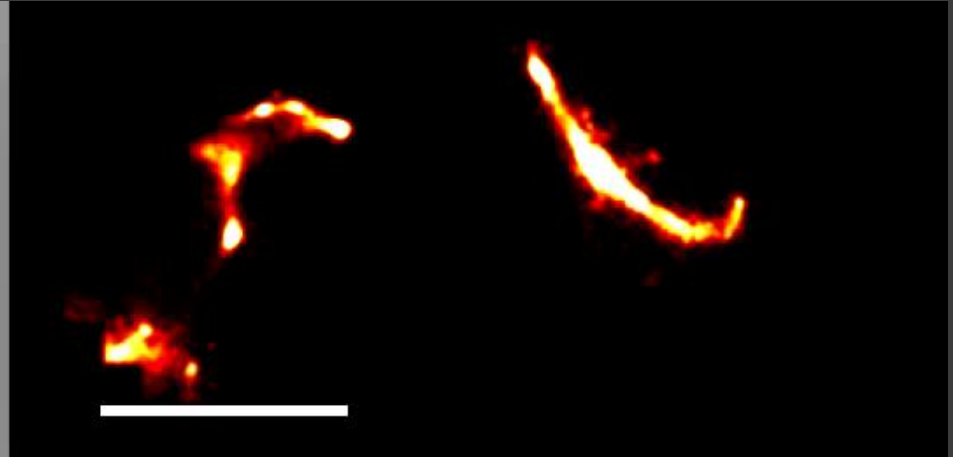

conclusion

PALM: irreversible photo-activation

- quantitative analyses, particle tracking, counting
- needs (in most cases) TIRF!

STORM, dSTORM, GSDIM, SPDM: reversible photo-switching

- resolution, fast
- also works without TIRF → imaging deeper inside cells

SPDM and GSDIM with FPs: (ir)reversible photo-switching

- quantitative analyses using conventional FPs
- also works without TIRF → imaging deeper inside cells

conclusion

resolution	quantitative and counting	particle tracking	speed (acquisition)	imaging deep in cells	use standard fluorophores	3D
(F)PALM	green	green	yellow	red	red	green
STORM	yellow	yellow	green	green	red	green
dSTORM	yellow	yellow	green	green	green	green
SPDM	green	green	yellow	green	green	green
GSDIM	yellow	yellow	green	green	green	green
SOFI	red	red	green	yellow	green	yellow
3B	yellow	red	green	yellow	green	red

referring to the original ideas of the methods

If you have a wide-field microscope with a laser for excitation of the fluorophores and one for switching/activating you can do ALL of these methods!

resolution	quantitative and counting	particle tracking	speed (acquisition)	imaging deep in cells	use standard fluorophores	3D
Single Molecule Localization Microscopy						
SOFI	red	red	green	yellow	green	yellow
3B	orange	red	green	yellow	green	red

referring to the original ideas of the methods

If you have a wide-field microscope with a laser for excitation of the fluorophores and one for switching/activating you can do ALL of these methods!

original (F)PALM and STORM:

<http://www.sciencemag.org/content/313/5793/1642.short>

<http://www.nature.com/nmeth/journal/v3/n10/full/nmeth929.html>

<http://www.sciencedirect.com/science/article/pii/S0006349506721403>

dSTORM, SPDM and GSDIM (with standard fluorophores):

<http://onlinelibrary.wiley.com/doi/10.1002/anie.200802376/full>

<http://www.springerlink.com/content/vx05p35kr3424228/>

<http://www.nature.com/nmeth/journal/v5/n11/full/nmeth.1257.html>

3D:

http://apl.aip.org/resource/1/applab/v97/i16/p161103_s1?view=fulltext

<http://www.pnas.org/content/106/9/3125.short>

live-cell applications:

<http://www.nature.com/nmeth/journal/v8/n6/abs/nmeth.1605.html>

<http://www.nature.com/nj/journal/v11/n1/full/nj.1832.html>

statistical data analysis:

<http://www.pnas.org/content/106/52/22275.short>

<http://onlinelibrary.wiley.com/doi/10.1111/j.1365-2818.2010.03436.x/full>

<http://www.plosone.org/article/info%3Adoi%2F10.1371%2Fjournal.pone.0031128>

high density particle tracking:

<http://www.nature.com/nmeth/journal/v5/n2/full/nmeth.1176.html>

<http://www.sciencedirect.com/science/article/pii/S0006349510007137>

Nat. Protoc.:

<http://www.nature.com/nprot/journal/v4/n3/abs/nprot.2008.246.html>

<http://www.nature.com/nprot/journal/v6/n7/abs/nprot.2011.336.html>

commercial systems:

<http://zeiss-campus.magnet.fsu.edu/articles/superresolution/palm/introduction.html>

http://www.nikoninstruments.com/en_GB/Products/Microscope-Systems/Inverted-Microscopes/Biological/N-STORM-Super-Resolution

<http://www.leica-microsystems.com/products/light-microscopes/life-science-research/fluorescence-microscopes/details/product/leica-sr-gsd/>

algorithms:

<http://www.super-resolution.biozentrum.uni-wuerzburg.de/home/rapidstorm/>

<http://code.google.com/p/quickpalm/>

summary and links:

<http://www2.bioch.ox.ac.uk/microngroup/research/localization-microscopy.shtml>