

# Brightfield contrast methods

Ian Dobbie  
Micron, University of Oxford  
March 2015  
ian.dobbie@bioch.ox.a.uk

## References:

D.B. Murphy, Fundamentals of Light Microscopy and Electronic Imaging

E. Hecht, Optics

M. Spencer, Fundamentals of Light Microscopy

# Goals

- Reiteration of how images are formed
- The limits of brightfield
- Darkfield microscopy
- Phase Contrast microscopy
- Differential Interference Contrast microscopy

# Two sets of conjugate planes in the microscope

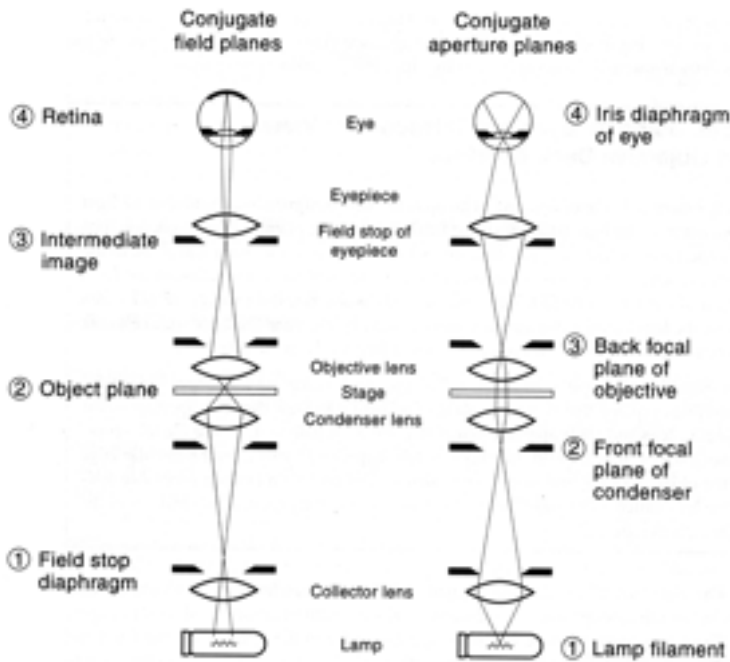

**Figure 1-4**  
 The locations of conjugate focal planes in a light microscope adjusted for Koehler illumination. Note the locations of four conjugate field planes (left) and four conjugate aperture planes (right) indicated by the crossover points of rays in the diagrams. The left-hand diagram shows that the specimen or object plane is conjugate with the real intermediate image plane in the eyepiece, the retina of the eye, and the field stop diaphragm between the lamp and the condenser. The right-hand drawing shows that the lamp filament is conjugate with aperture planes at the front focal plane of the condenser, the back focal plane of the objective, and the pupil of the eye.

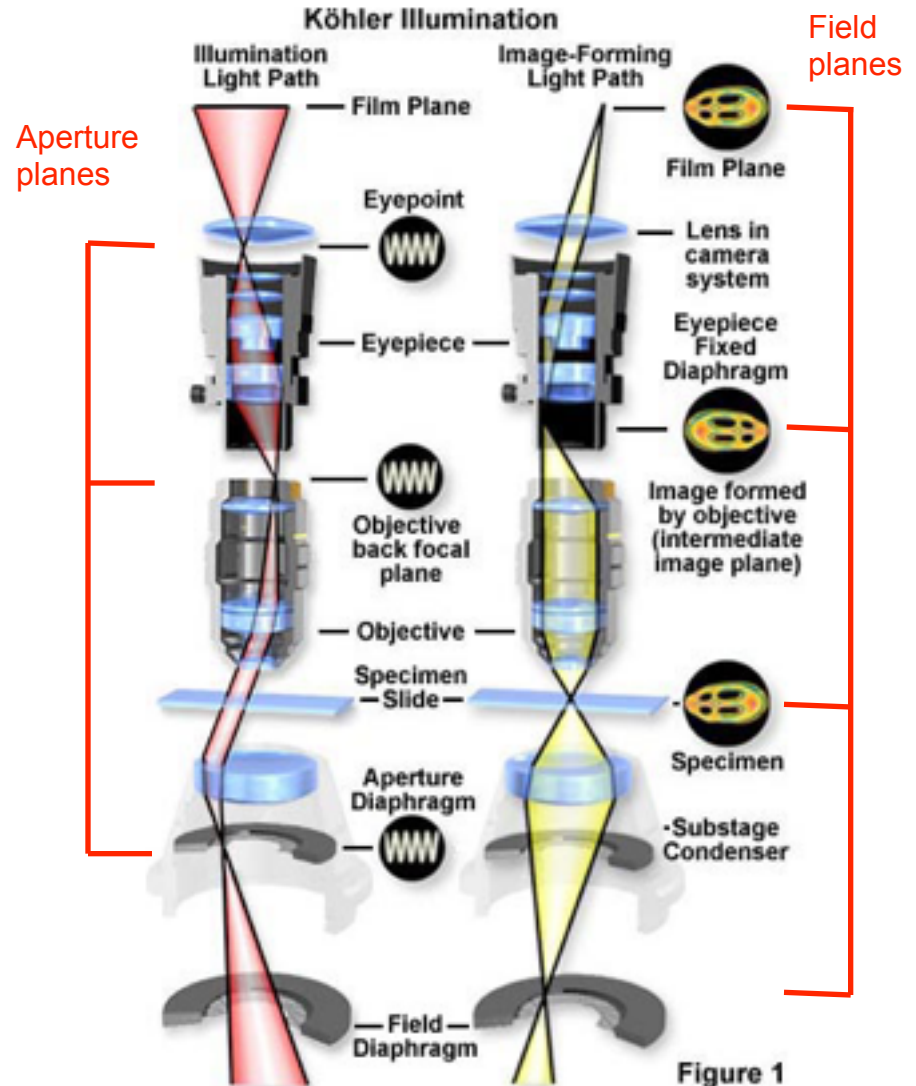

**Figure 1**

# Image formation a la Abbe

- The specimen diffracts light in all directions.
- The lens refracts the light diffracted by the specimen and focuses it at the image plane
- At the image plane, the redirected light interferes constructively and destructively to create an image of the specimen.
- This image formation is the result of interference between diffracted and undiffracted light.
- The intensities of the diffraction pattern at the objective back focal plane correspond to spatial frequencies within the specimen.

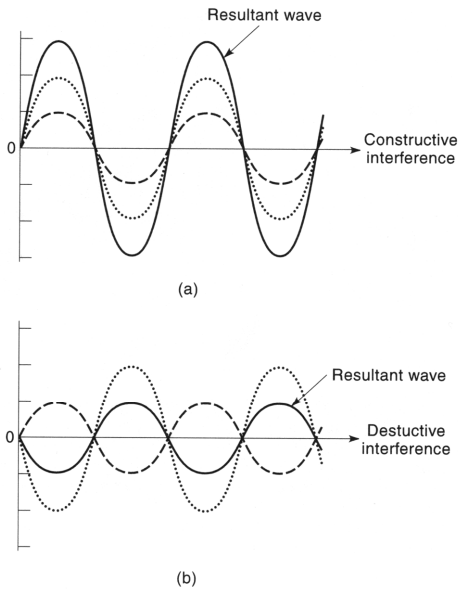

Figure 5-3

Two coincident waves can interfere if their E vectors vibrate in the same plane at their point of intersection. Two waves are shown that vibrate in the plane of the page. In these examples, both waves (dotted and dashed curves) have the same wavelength, but vary in amplitude. The amplitude of a resultant wave (solid curve) is the arithmetic sum of the amplitudes of the two original waves. (a) Constructive interference occurs for two waves having the same phase. (b) Destructive interference occurs for waves shifted in phase; if the amplitudes of the waves are the same and the relative phase shift is  $\lambda/2$ , the wave is eliminated.

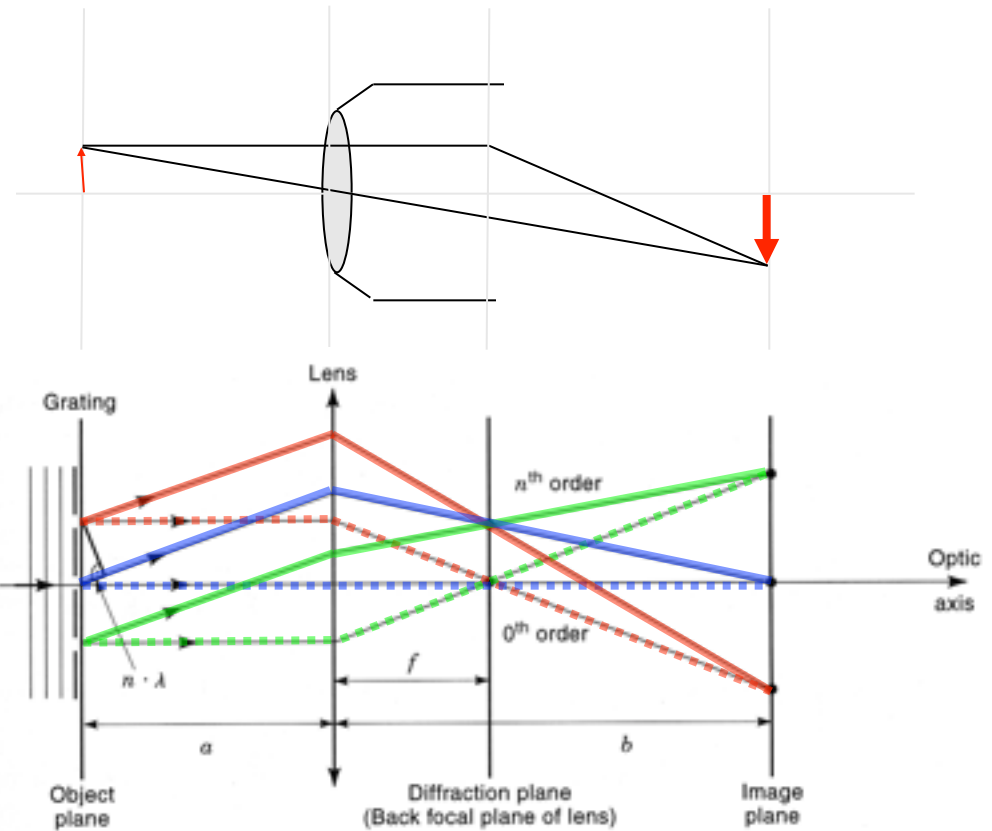

Figure 5-14

Abbe's theory for image formation in a light microscope. An objective lens focused on a grating ( $2f > a > f$ ) in the object plane produces a magnified real image of the grating in the image plane. The diffraction plane is located at  $1/f$  in the back aperture of the lens. An incident planar wavefront is shown. Diffracted  $n^{\text{th}}$ -order and nondiffracted  $0^{\text{th}}$ -order rays are separated in the diffraction plane, but are combined in the image plane.

In this example, the grating is an (idealised) model test specimen

# True "brightfield" imaging

- With only a condenser and an objective, there is always a trade-off between contrast and resolution

Condenser "open"  
Resolution high  
Contrast low

Condenser "closed" (i.e., stopped down)  
Resolution low  
Contrast high

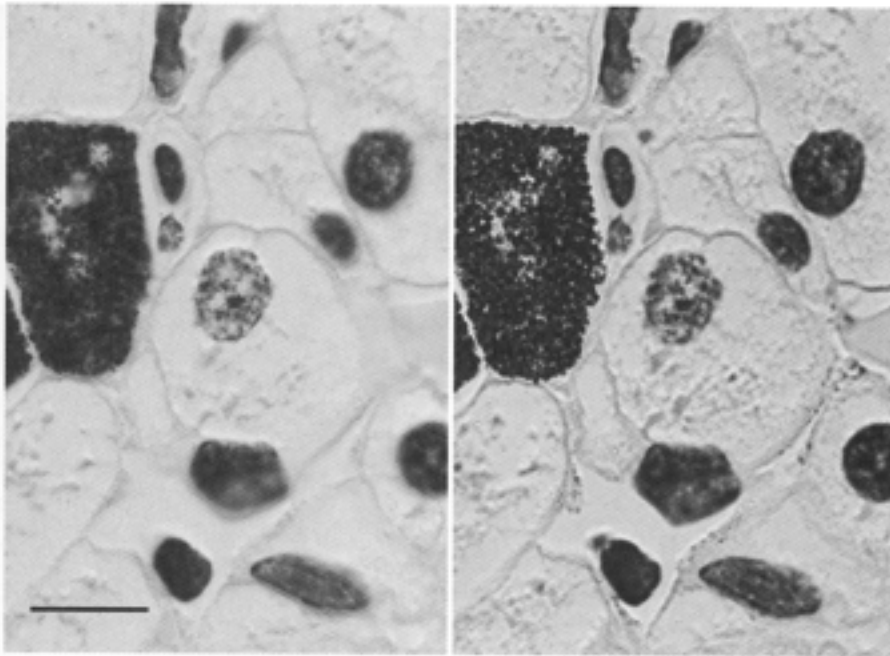

(a)

(b)

Figure 6-6

Effect of the condenser aperture on image contrast and resolution. (a) With unrestricted aperture, resolution is maximal, but contrast suffers from stray light. (b) With the condenser aperture stopped down, light fills ~70% of the diameter of the back aperture of the objective. Contrast is improved, but resolution is reduced. Bright-field light micrograph of a hematoxylin-stained section of *Amphiuma* liver containing hepatocytes and pigment cells. Bar = 10  $\mu\text{m}$ .

Lower condenser N.A. gives lower resolution

Why does contrast increase with lower condenser N.A.?

- Reduction of stray light bouncing in side the microscope
- "Fuzzy" images are bigger and cover more cells in your retina (or area in a camera)
- Closing the condenser aperture increases the coherence of light coming from the lamp filament, giving better interference in the image plain (complicated)

# Altering brightfield contrast--cheek epithelial cell

Condenser open,  
objective in focus

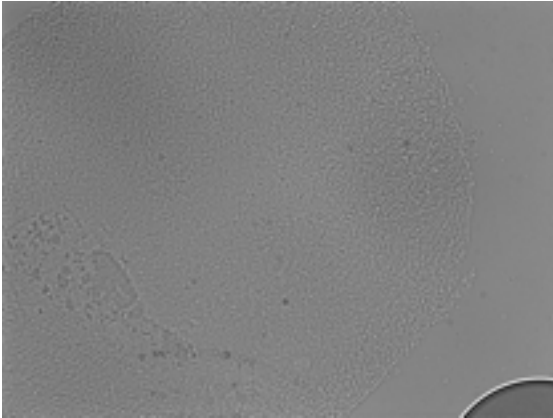

Condenser open,  
objective underfocused

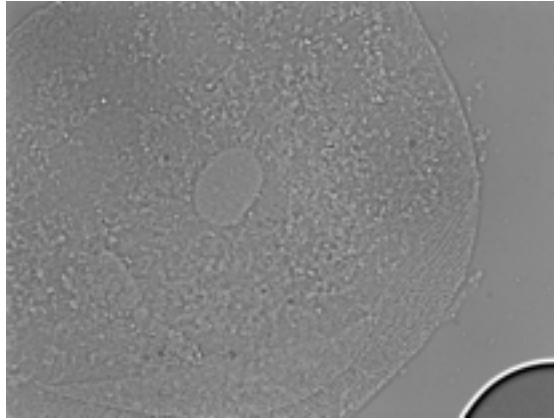

Condenser open,  
objective overfocused

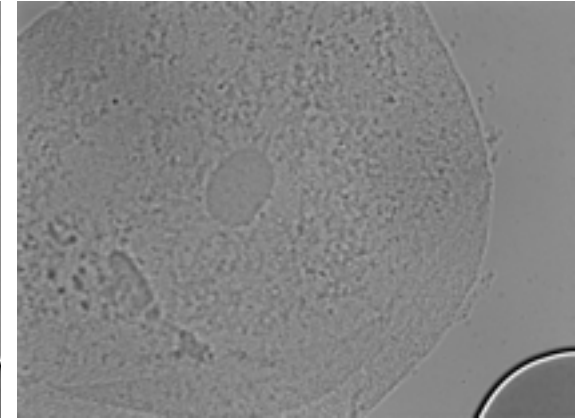

Condenser open,  
objective in focus

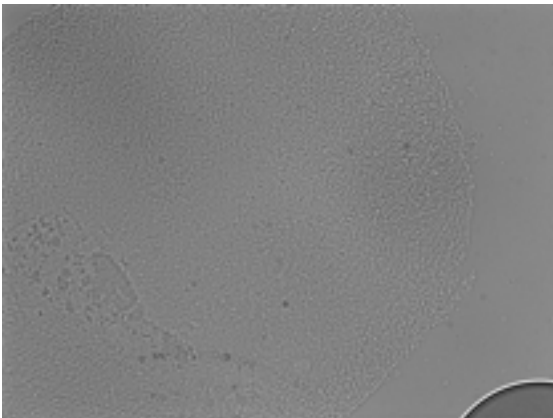

Condenser stopped down,  
objective in focus

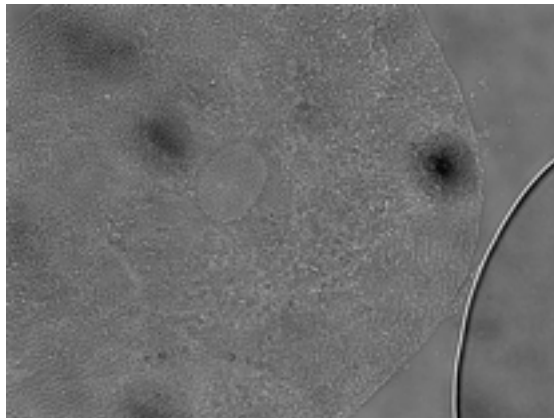

Condenser open,  
objective in focus (DIC)

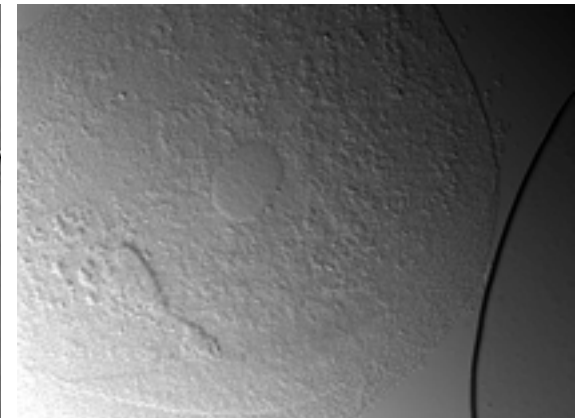

# Problems in imaging live cells

- Stained (i.e., dead) cells can "absorb" light, as amplitude objects
- Live cells are largely transparent, absorbing almost no light and scattering relatively little
- How can we best image living cells?

Brightfield



Darkfield

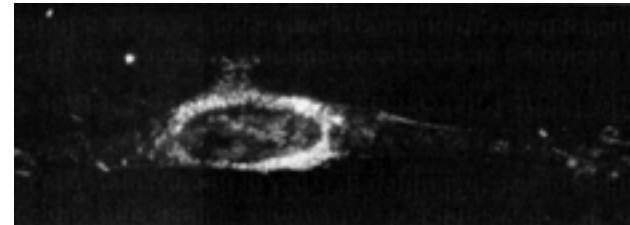

Phase contrast

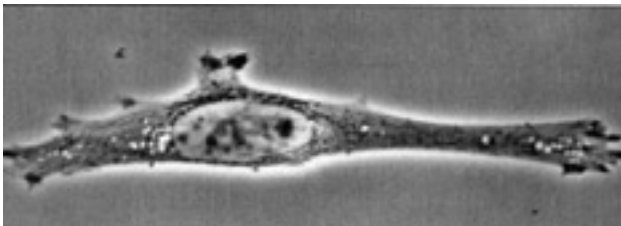

Differential interference contrast





# A Darkfield digression

- A hollow cone of light from the condenser
- A very high N.A. condenser (for darkfield this must be bigger than the objective N.A.), such that undiffracted 0th order light does not enter the objective



Figure 7-13

Optical scheme for dark-field microscopy. The geometry allows only diffracted light to be collected by the objective lens. Direct, nondiffracted rays are inclined at a steep angle and miss the objective entirely.

Darkfield images appear self-luminous (like fluorescence images)

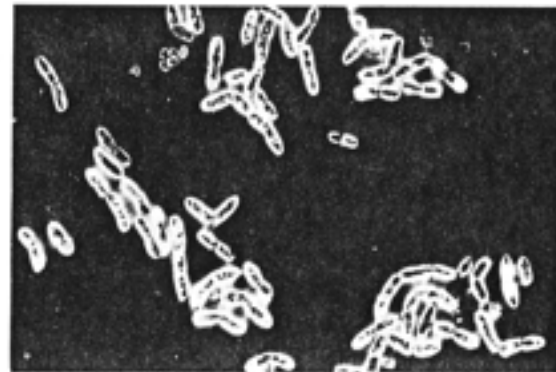
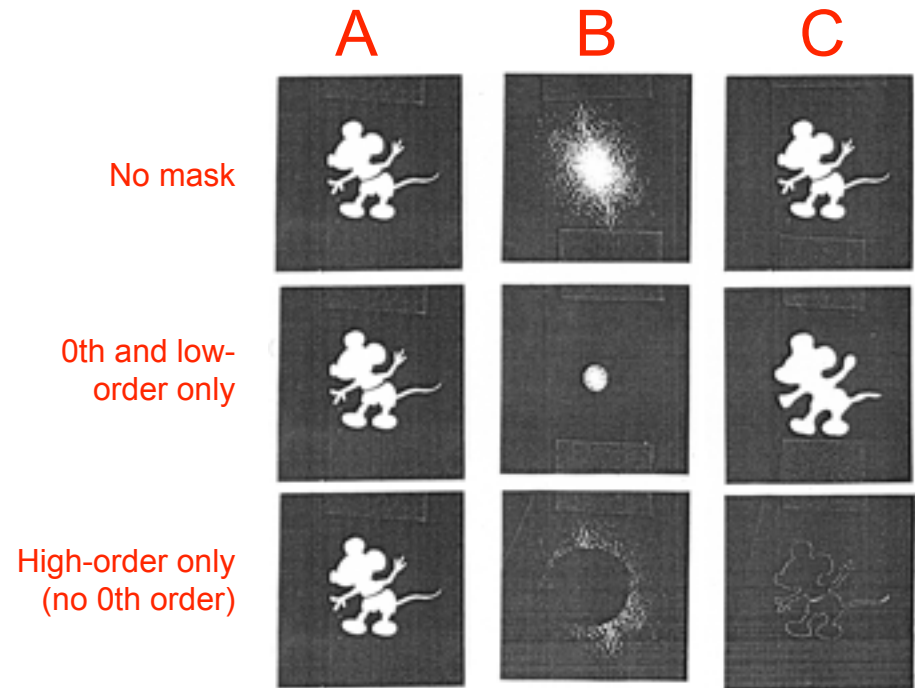
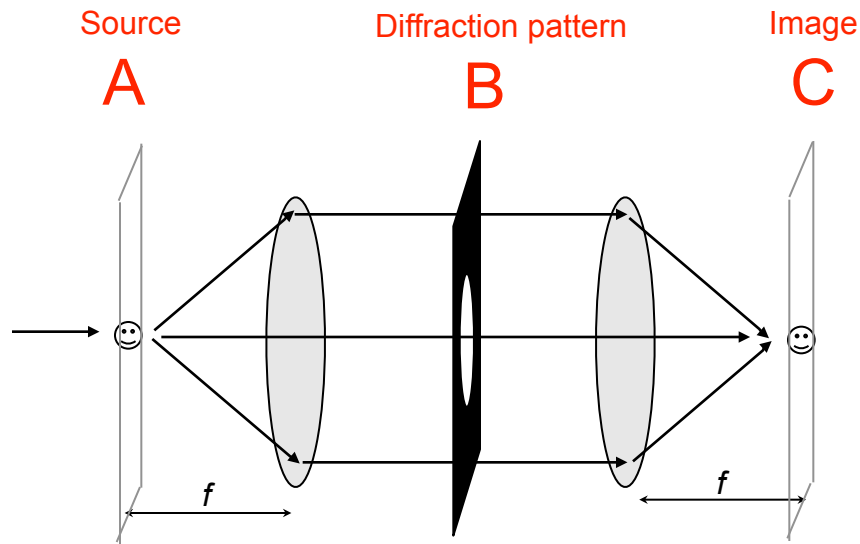

Fig. 26. *Bacillus megatherium* under dark-field illumination.



# Optical diffractometer analog of Darkfield

- With higher-orders masked out can see trade-off between contrast and resolution
- With 0th and lower-orders masked out can see an see detailed structure but little contrast
- The point (for what's to follow) is that you can affect ultimate image contrast by mucking around with the diffraction pattern (in back focal plane of objective)



# Phase contrast: phase objects vs. amplitude objects

- Even transparent objects change the phase of the light that goes through them

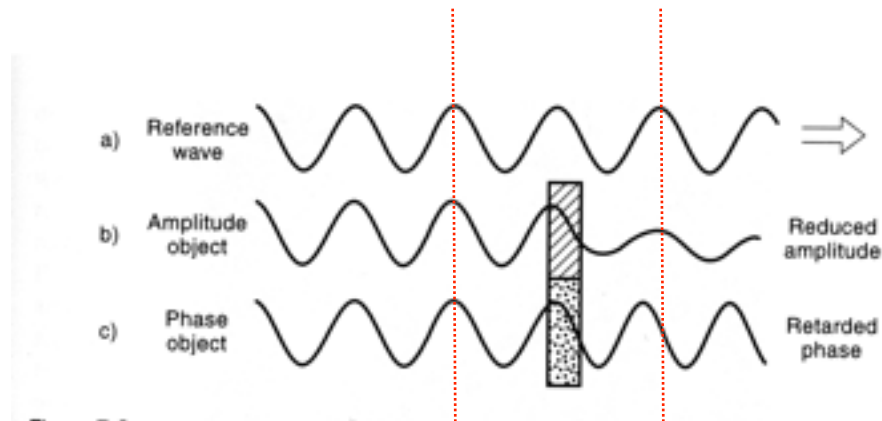
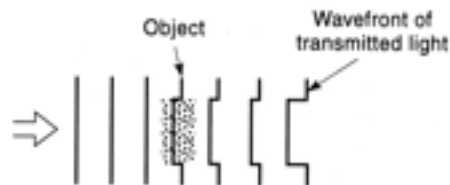

Figure 7-2

Effects of amplitude and phase objects on the waveform of light. (a) Reference ray with characteristic amplitude, wavelength, and phase. (b) A pure amplitude object absorbs energy and reduces the amplitude, but does not alter the phase, of an emergent ray. (c) A pure phase object alters velocity and shifts the phase, but not the amplitude, of an emergent ray.



$$(n_{\text{sample}}/n_{\text{medium}}) * \text{distance} = \text{optical path difference}$$

Figure 7-3

Disturbance by a phase object to an incident planar wavefront.

# The phase-shift produced by phase objects

- The phase-modulated wave  $P$  can be represented as the sum of an unaffected wave ( $S$ ) and a wave that is  $\lambda/4$  ( $= \pi/2$ ) out of phase ( $D$ ).
- However, this does not produce any useful contrast, as  $P$  and  $S$  have the same amplitudes (i.e., the interference is neither constructive nor destructive).

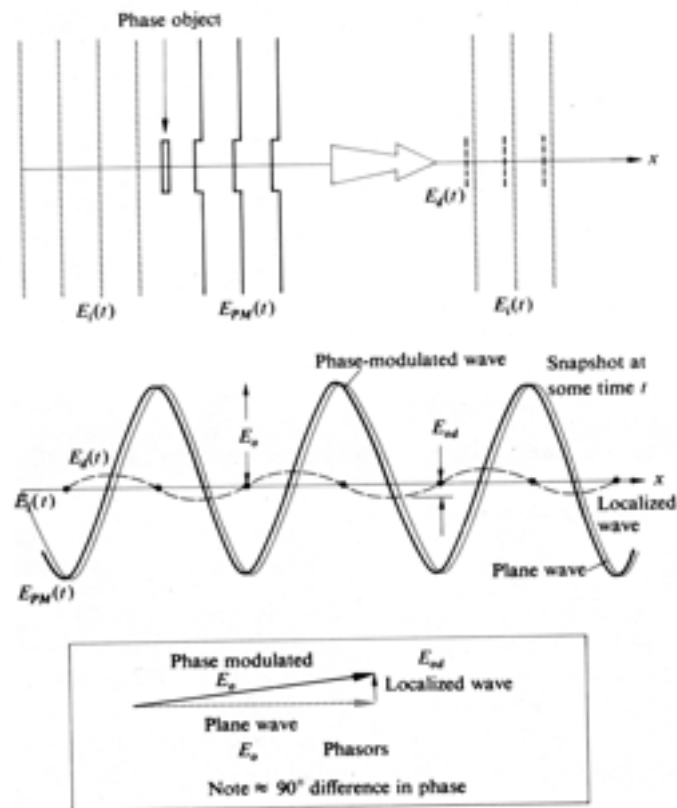

Figure 14.17 Wavefronts in the phase-contrast process.

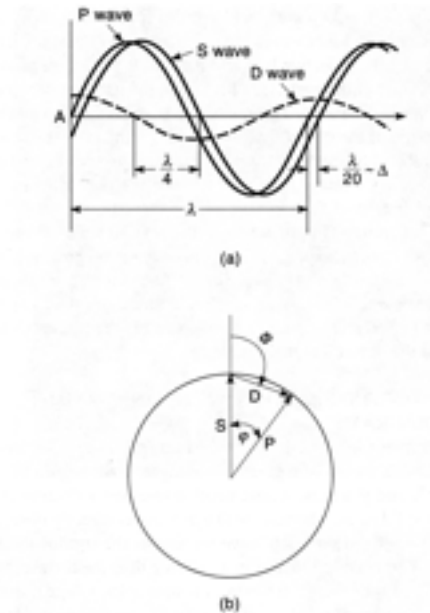

Figure 7-5

Phase relations between S, D, and P waves in bright-field microscopy. S and D waves, generated at the object, recombine through interference to generate the resultant particle image wave (P) in the image plane of the microscope ( $P = S + D$ ). Relative to S, the D wave has a lower amplitude and is retarded in phase by  $-\lambda/4$ . The slight phase shift of  $\lambda/20$  in the resultant P wave is related to the optical path length difference and is typical for small object details in a cell. Since the amplitudes of the S and P waves are the same, the contrast is 0, and the object remains invisible against the background. (a) Wave components shown as sine waves. In this chapter, sine waves represent the amplitude and phase of a whole population of waves, not single photons. Thus, the lower amplitude of the D wave does not mean energy was absorbed, but rather that there are fewer D waves than there are S waves. (b) Vector diagram of S, P, and D waves. For explanation, see text.

# Analytical treatment of Phase Contrast

Copied and adapted from Hecht, "Optics"

There is a relatively simple argument to justify using a quarter-wave plate at the back-focal plane of the objective, from a mathematical perspective that doesn't need to appeal to the physical nature of diffraction. The function of the plate is to make the phase difference between the 0<sup>th</sup> order and higher-order (diffracted) beams exactly one-half wavelength ( $\pi$ ), so that they can interfere, either constructively or destructively, at the image plane (conjugate to the specimen plane) of the microscope. The quarter-wave plate shifts any existing phase difference by  $\pi/2$ , so the question is, what makes the initial phase difference  $\pi/2$ ?

One can show that small phase perturbations can be represented at the specimen plane by a function that is phase-shifted from the undiffracted plane wave by  $\pi/2$ , as follows:

Incoming light at the specimen plane is represented as:

$$E_i(x,t) = E_0 \sin \omega t \quad (x=0 \text{ at the specimen plane})$$

A phase-dark particle causes a local phase perturbation  $\phi(y,z)$  of the plane wave at the specimen plane, so that the phase-modulated (PM) wave leaving the specimen at  $x=0$  is:

$$E_{PM}(r,t) = E_{PM}(x,y,z,t) = E_0 \sin(\omega t + \phi(y,z)) \quad (\text{recall that } x=0 \text{ here})$$

"This is a constant-amplitude wave which is essentially the same on the conjugate image plane." At either the conjugate image plane or at the specimen plane (since they are equivalent) we can expand this equation (using rules of trigonometry) to:

$$E_{PM}(y,z,t) = E_0 \sin \omega t \cos \phi + E_0 \cos \omega t \sin \phi$$

If we assume that phase perturbations  $\phi$  are small (this is the key to the argument), we can approximate the above equation (again using rules of trigonometry) as:

$$E_{PM}(y,z,t) = E_0 \sin \omega t + E_0 \phi(y,z) \cos \omega t$$

All of the phase information in the above equation is now present in the second term, which is out of phase with the first term by  $\pi/2$ .

In this analysis, the addition of an quarter-wave plate at the back-focal plane of the objective will leave the 0<sup>th</sup> order undiffracted light unchanged but the effect of the quarter-wave plate on the diffracted light will be to change the cos in the second term to sin, thus converting a phase-modulated wave  $E_{PM}$  to an amplitude-modulated wave  $E_{AM}$ , which we can see:

$$E_{AM}(y,z,t) = E_0 (1 + \phi(y,z)) \sin \omega t$$

# What we would like to do to achieve phase contrast in the microscope

- In reality, the amplitude of the  $\lambda/4$ -shifted component is VERY small

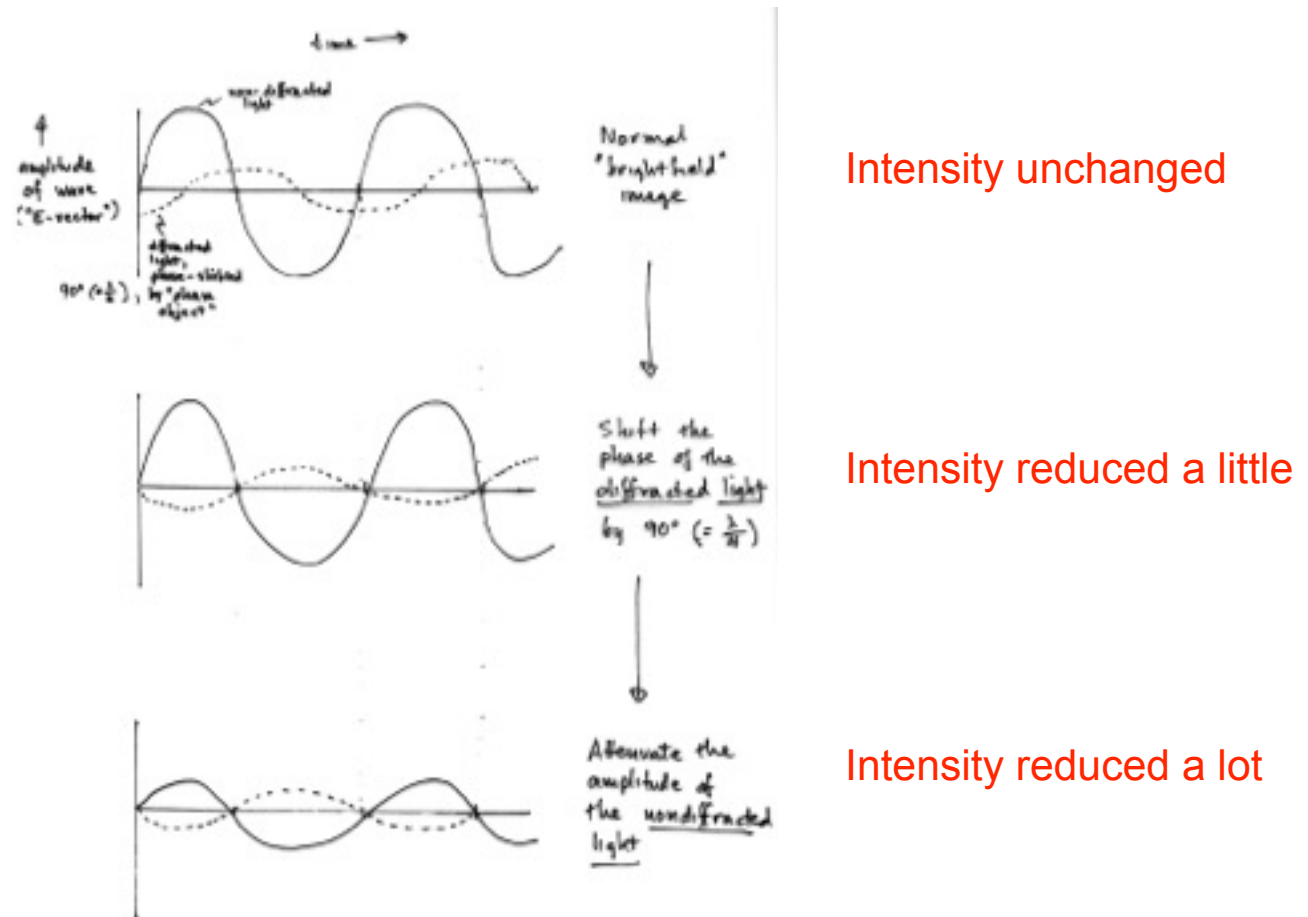

# How can you specifically alter the phase of the light that is scattered by the specimen?

- Using the diffraction gradient as a model for the specimen, the Abbe theory shows that at the back focal plane of the objective, the diffracted (scattered) light is spatially separated from the undiffracted (0th order) light

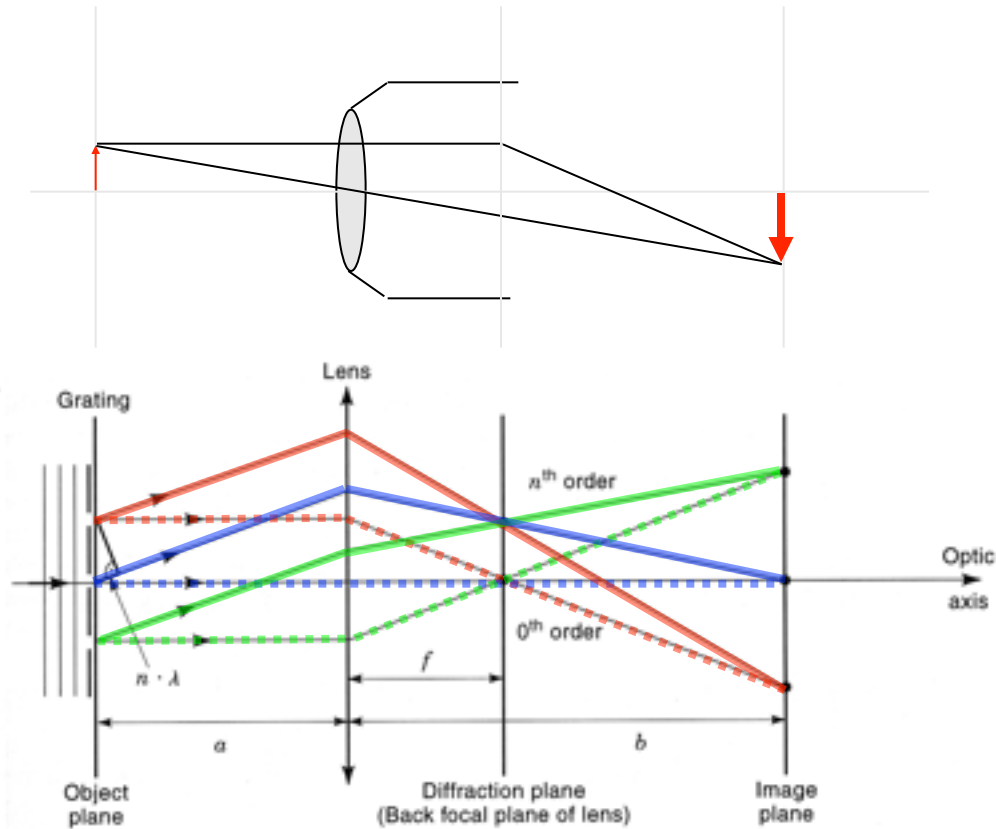

Figure 5-14

Abbe's theory for image formation in a light microscope. An objective lens focused on a grating ( $2f > a > f$ ) in the object plane produces a magnified real image of the grating in the image plane. The diffraction plane is located at  $1f$  in the back aperture of the lens. An incident planar wavefront is shown. Diffracted  $n$ th-order and nondiffracted 0th-order rays are separated in the diffraction plane, but are combined in the image plane.

# In the back focal plane, diffracted and undiffracted light are spatially separated

- This simplified example shows illumination by parallel light rays (not a cone of light)

Figure 14.16 Phase-contrast setup.

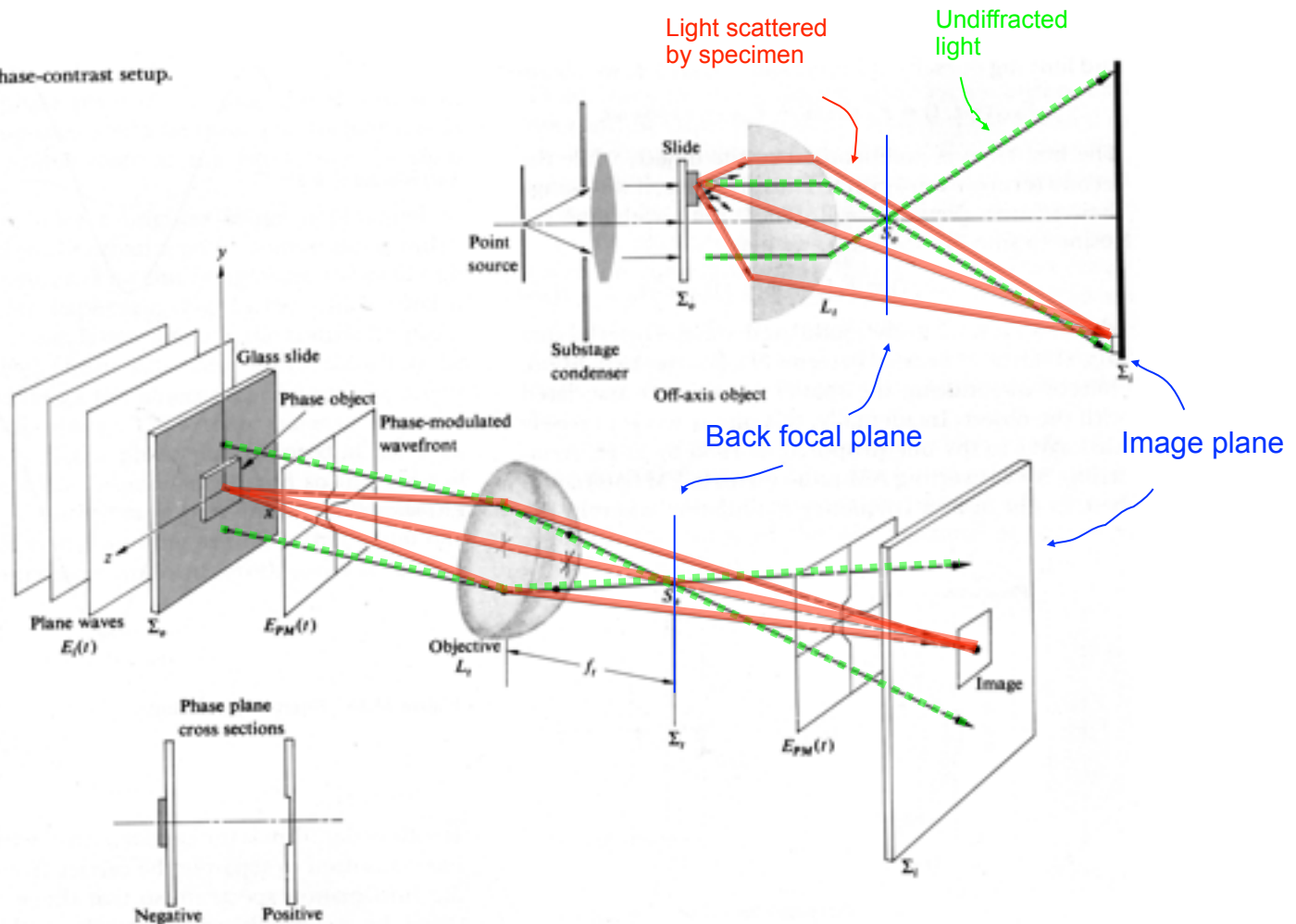



# Phase contrast setup in the microscope

- Same principle as in previous slide, but now in the context of a cone of illuminating light
- The key trick is using a "hollow" cone of illumination rather than a "solid" cone.

The phase plate is darkened to attenuate 0th order light (this is good for phase contrast but less good for fluorescence)

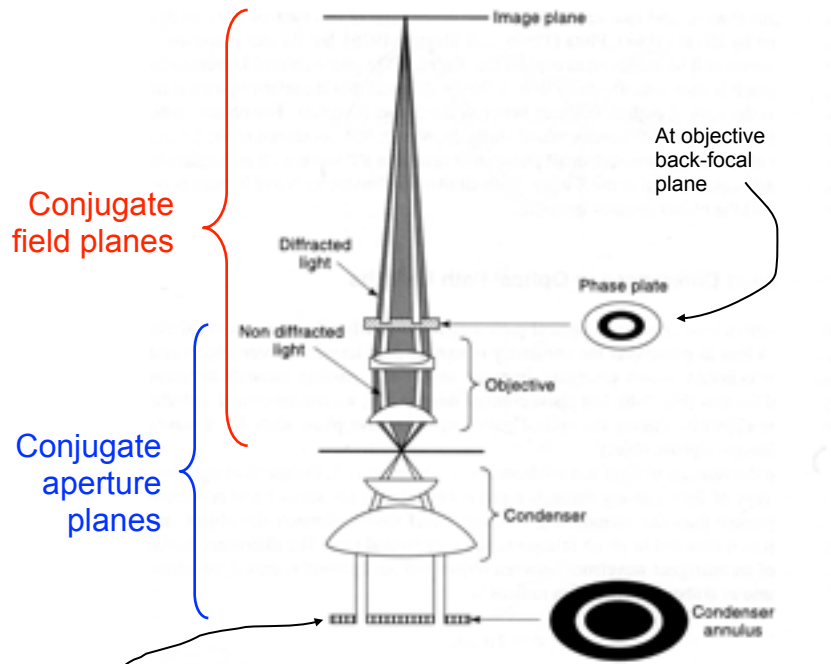

Figure 7-6

Path of nondiffracted and diffracted beams in a phase contrast microscope. An annular aperture in the front focal plane of the condenser generates a hollow cone of light that illuminates the specimen and continues (approximately) as an inverted cone that is intercepted by a phase plate at the back aperture of the objective lens. The image of the annulus is in sharp focus in this plane because it is conjugate to the front aperture plane of the condenser. Diffracted specimen rays fill the shaded region of the illumination path.

This is where the aperture diaphragm would be for normal brightfield microscopy

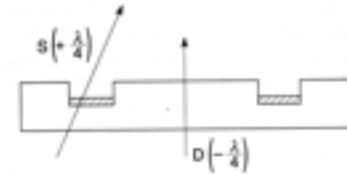

Figure 7-7

The action of a phase plate at the rear surface of the objective lens. Surround or background rays (S) are advanced in phase relative to the D wave by  $\lambda/4$  at the phase plate. Relative phase advancement is created by etching a ring in the plate that reduces the physical path taken by the S waves through the high-refractive-index plate. Since diffracted object rays (D) are retarded by  $\lambda/4$  at the specimen, the optical path difference between D and S waves upon emergence from the phase plate is  $\lambda/2$ , allowing destructive interference in the image plane. The recessed ring in the phase plate is made semitransparent so that the amplitude of the S wave is reduced by 70–75% to optimize contrast in the image plane.

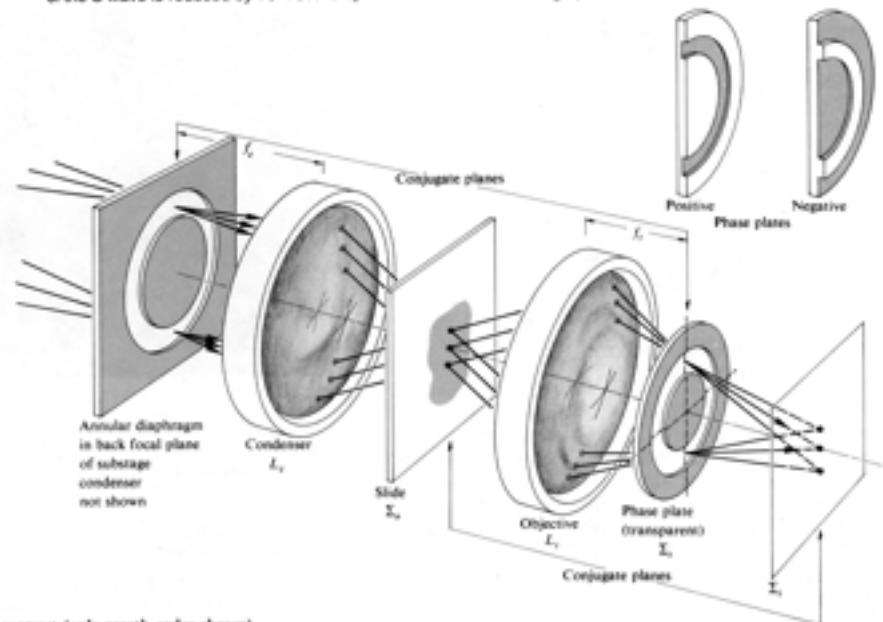
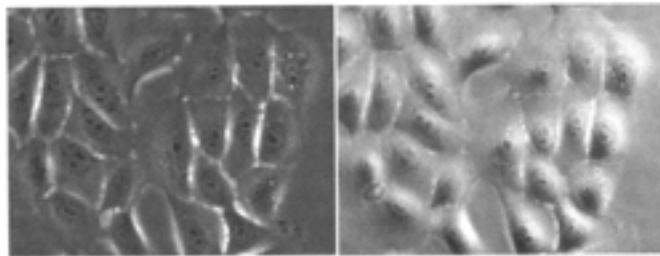
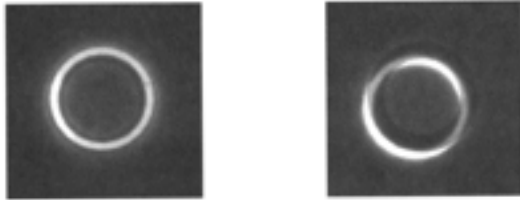

Figure 14.19 Phase contrast (only zeroth order shown).

# Some practical aspects of phase contrast

Misalignment of the condenser phase annulus leads to imaging artefacts

- A phase-telescope or Bertrand lens is used to ensure that the two rings are aligned



(a)

(b)

Figure 7-9

Alignment of condenser and objective annuli. An eyepiece telescope or Bertrand lens is used to examine the back aperture of the objective lens. (a) The dark ring of the phase plate must be perfectly centered with the bright ring of light from the condenser annulus. The adjustment is made using two condenser plate-centering screws. These screws are distinct from the condenser centration screws, which are used to center the condenser lens with respect to the optic axis of the microscope. (b) Notice the low-contrast shaded image resulting from a misaligned annulus.

"Phase halo" at the edge of highly refractile specimens--this is unavoidable and due in part to lower-order scattered light passing through the phase plate where the 0th order light would pass (i.e., no interference)

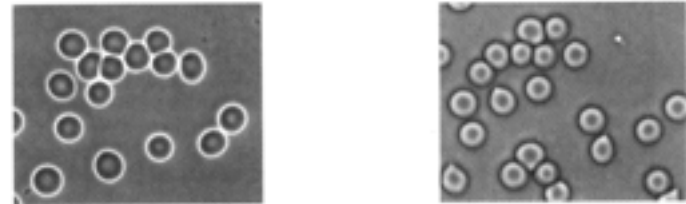

Figure 7-8

Comparison of positive and negative phase contrast systems. Shown in pairs, from the top down: phase plates for advancing (positive contrast) or retarding (negative contrast) the surround wave; amplitude profiles of waves showing destructive interference (positive phase contrast) and constructive interference (negative phase contrast) for a high-refractive-index object. Notice that the phase plate advances or retards the S wave relative to the D wave. The amplitude of the resultant P wave is lower or higher than the S wave, causing the object to look relatively darker or brighter than the background. Vector diagrams showing advancement of the S wave by  $\lambda/4$ , which is shown as a 90° counterclockwise rotation in positive phase contrast, and retardation of the S wave by  $\lambda/4$ , which is shown as a 90° clockwise rotation in negative phase contrast. Addition of the S and D wave vectors gives P waves whose amplitudes vary relative to the S waves. Images of erythrocytes in positive and negative phase contrast optics.

Plus--the dark phase ring can be less than optimal for fluorescence (and sometimes autofluorescent!)

# Differential Interference Contrast (Nomarski)

- Whereas phase contrast generates contrast from absolute difference in optical path (OPD), DIC generates contrast from relative differences in optical path (i.e.,  $dOPD/dx$ )

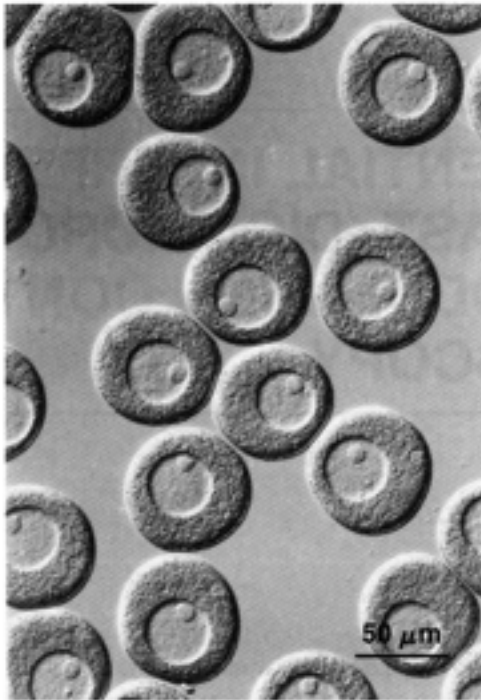

Figure 10-1

Primary oocytes of the surf clam, *Spissula solidissima*, in DIC optics. The gradients of shading in the image indicate regions of rapidly changing optical path length in the cell. The large specialized nucleus and prominent dense nucleolus comprise the germinal vesicle in these meiotic cells.

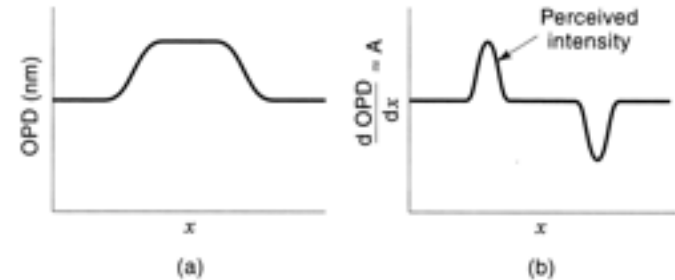

Figure 10-2

Gradients in optical path length yield differences in amplitude. (a) Plot of optical path length across the diameter of a phase-dense object. (b) Derivative of the optical path length curve shown in (a) added to a constant gives the amplitude profile perceived using DIC optics. Positive and negative slopes in (a) correspond to regions of higher and lower amplitude. Regions of the object exhibiting no change in slope have the same amplitude as the background.

# To understand how DIC works we need to understand polarized light

- Just as we can't see phase, nor can we see polarization.
- Some animals can see polarization, e.g. bees and octopus

Figure 8.1 Linear light.

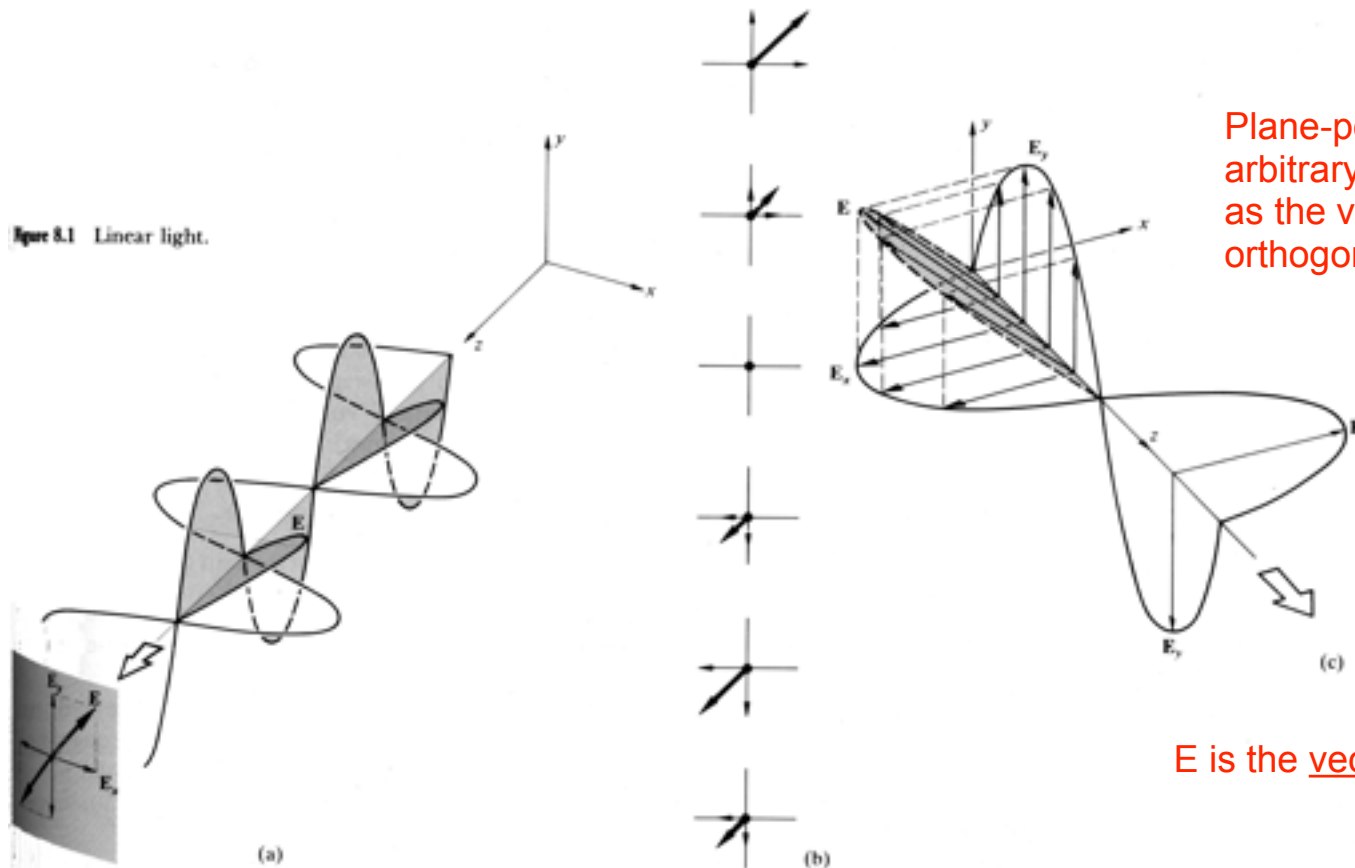

Plane-polarized light in any arbitrary plane can be thought of as the vector sum of two orthogonal polarized components

$E$  is the vector sum of  $E_x$  and  $E_y$

# Circularly polarized light

- What happens when the orthogonal components  $E_x$  and  $E_y$  are out of phase?

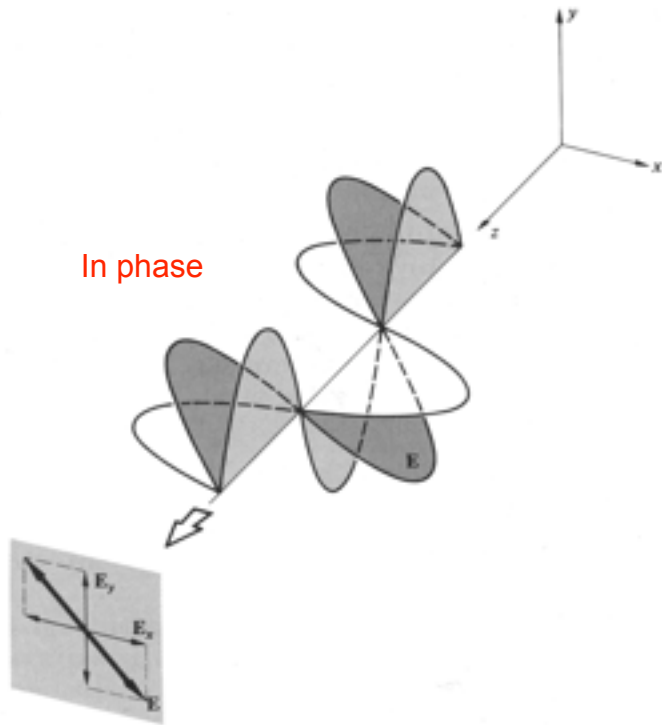

Figure 8.2 Linear light.

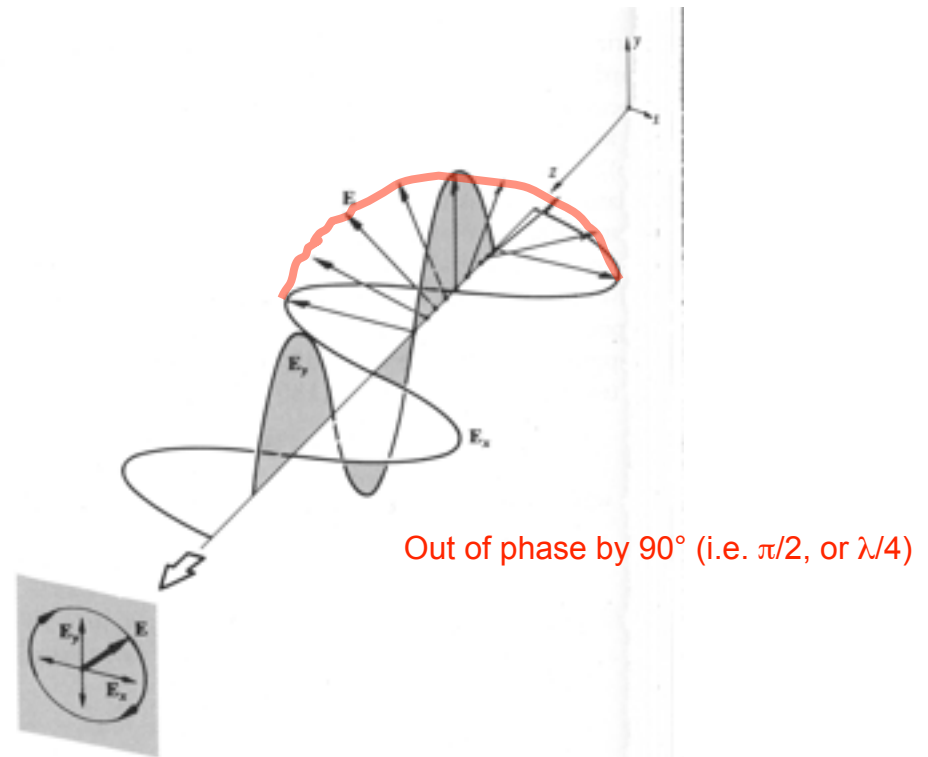

Figure 8.3 Right-circular light.

# Plane-polarized and circularly-polarized light are both special cases of elliptically polarized light

These are  $90^\circ$  ( $\pi/2$ ) out of phase. Imagine what the polarization vector would look like if the  $E_x$  and  $E_y$  components were  $45^\circ$  out of phase (i.e.  $\pi/4$ , or  $\lambda/8$ )...

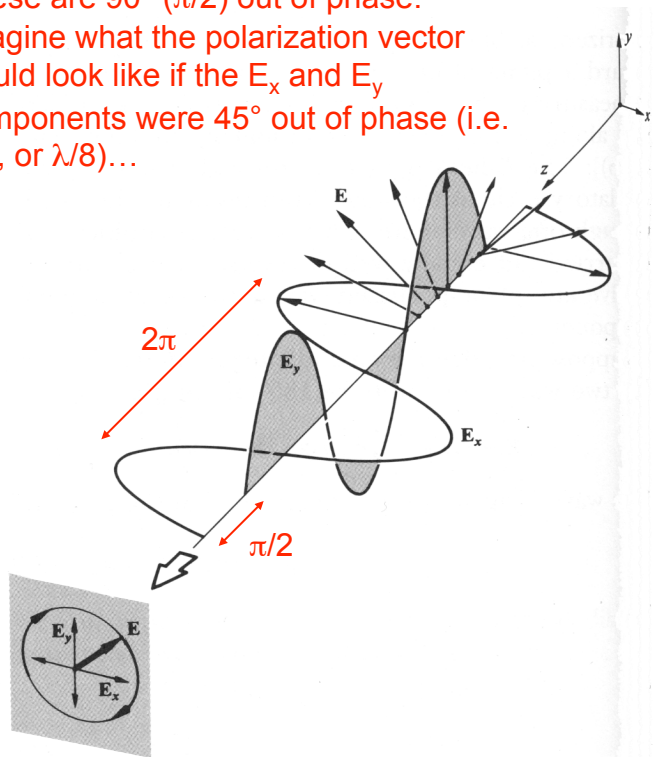

Figure 8.3 Right-circular light

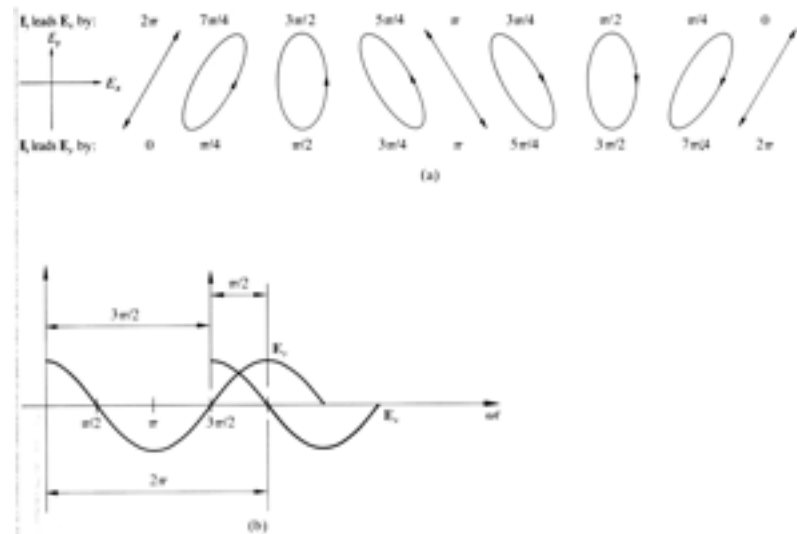

Figure 8.7 (a) Various polarization configurations. The light would be circular with  $\alpha = \pi/2$  or  $3\pi/2$  if  $E_{0x} = E_{0y}$ , but here for the sake of generality  $E_{0x}$  was taken to be larger than  $E_{0y}$ . (b)  $E_x$  leads  $E_y$  (or  $E_y$  lags  $E_x$ ) by  $\pi/2$ , or alternatively,  $E_x$  leads  $E_y$  (or  $E_y$  lags  $E_x$ ) by  $3\pi/2$ .

# (Birefringent crystal interlude)

- Essentials of the DIC set-up:
- Two polarizers, at right angles to each other ("no transmission through crossed polarizers")
- Calcite (Iceland spar), a birefringent crystal that splits polarized light into two distinct beams that are spatially separated and orthogonally polarized (O-rays and E-rays).



# Two representations of the (same) DIC setup

- Polarizer polarizes the light (recall that polarizer and analyzer will be at right angles to each other).
- Wollaston I splits the polarized light into two orthogonally polarized beams, which are also slightly separated spatially (this is what "measures"  $dOPD/dx$ ).
- The two beams travel through (very closely) neighbouring parts of the specimen. Where appropriate (i.e., where  $dOPD/dx \neq 0$ ), a phase difference  $\Delta$  is introduced.
- Wollaston II recombines the beams. When there is no phase difference  $\Delta$ , the result is linearly polarized light that cannot pass through the analyzer.
- But when there is phase difference  $\Delta$ , the result is elliptically polarized light, and the component of this light parallel to the analyzer axis can pass through the analyzer.

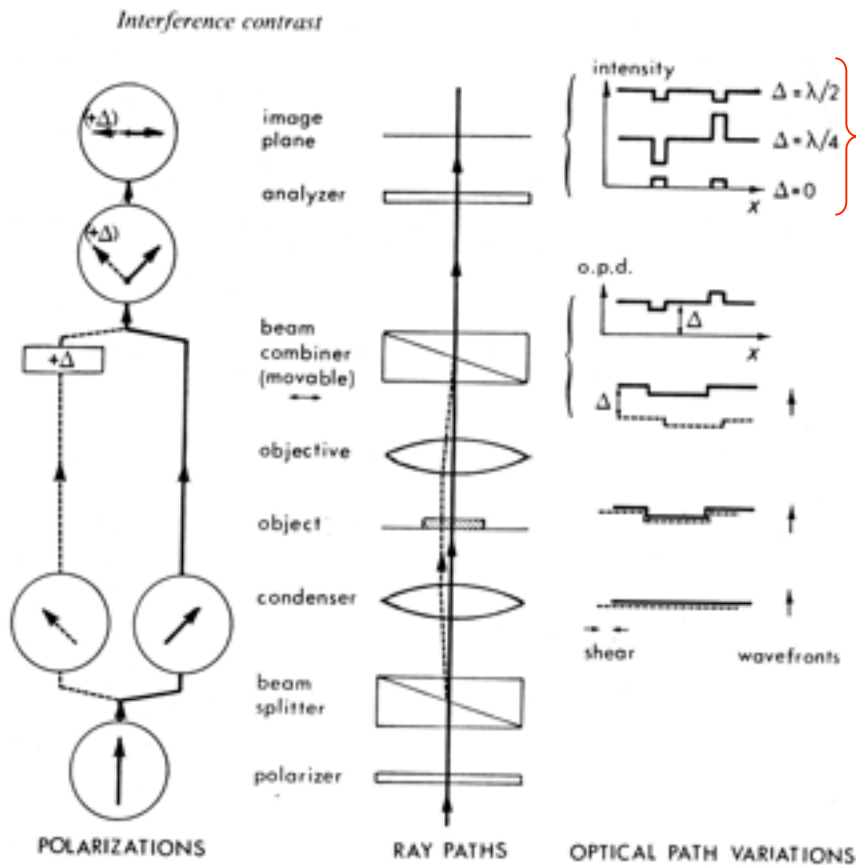

This part is a little complicated and has to do with bias retardation

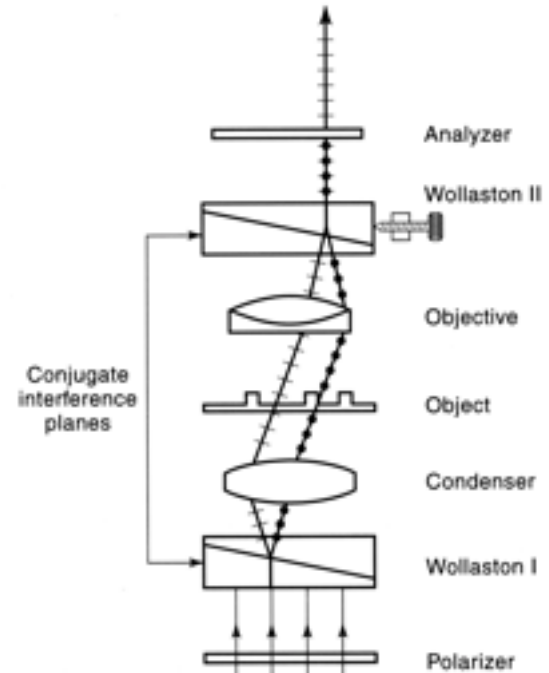

Figure 10-3

Optical components of a DIC microscope. Two polarizers (polarizer and analyzer) and two modified Wollaston prisms (DIC or Nomarski prisms) are required. The condenser DIC prism acts as a beam splitter, producing two closely spaced parallel beams that traverse the object and are recombined by the objective DIC prism. The dots and dashes indicate the mutually perpendicular vibrations of the two components of the split ray as defined in Figure 8-7.

Fig. 38. The optical system for interference contrast.

# Why DIC detects edges

- A phase shift of the O-ray relative to the E-ray results in elliptically polarized light after the two rays are recombined by Wollaston II (often called the "top" Wollaston).
- The component of the elliptically-polarized light that is parallel to the analyzer axis passes through.

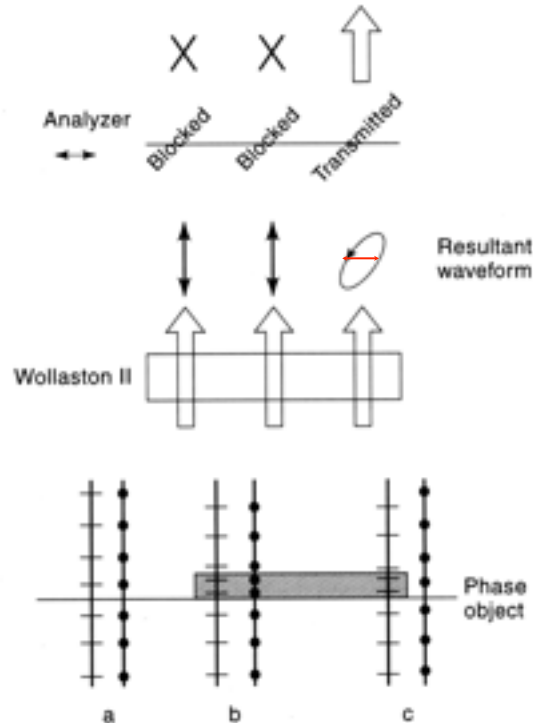
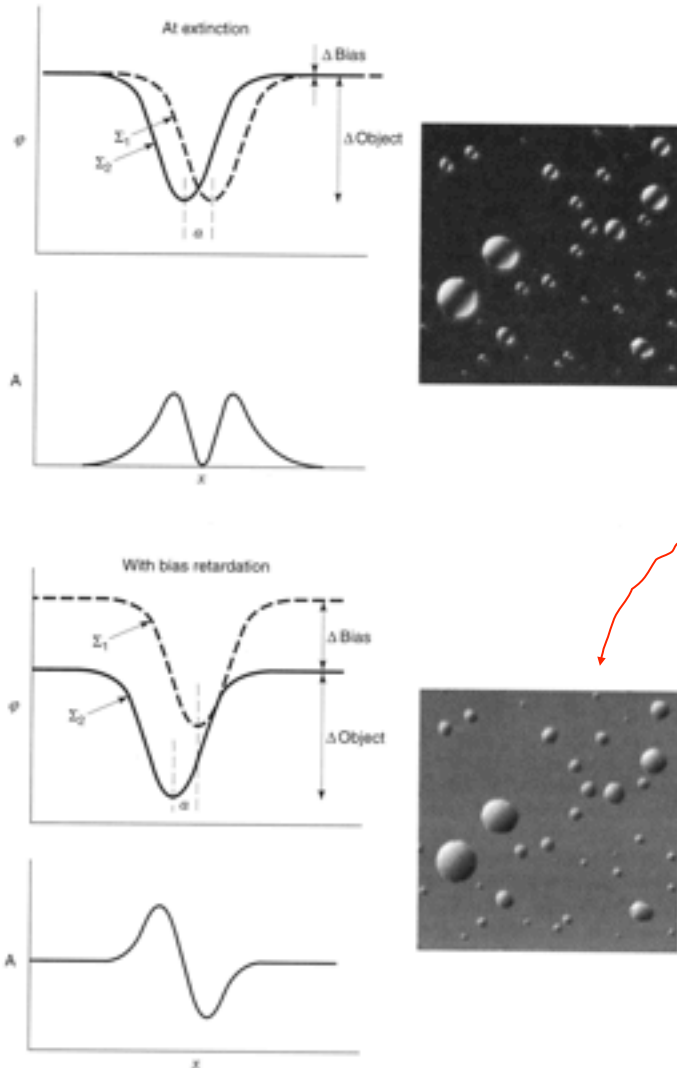

Figure 10-5

Progression of rays through the DIC microscope. An incident beam of linearly polarized light is split by the condenser DIC prism into O- and E-ray components that are focused by the condenser lens onto the specimen. The two rays follow separate parallel trajectories between the condenser and objective lenses. (a, b) In the absence of an optical path difference, the O and E rays are combined by the objective prism, giving linearly polarized light that vibrates in the same plane as the polarizer and is completely blocked by the analyzer. (c) If an optical path difference (phase shift) exists, the prism recombines the beams, giving elliptically polarized light that is partially transmitted by the analyzer.

# Bias retardation causes the 3-D shadow effect

This part a little hard to understand--see next slide



If you do it just as described thus far, this is what you get--maximum extinction--background is darkest, and both edges are bright

Bias retardation introduced (selectively phase-shifts one of the orthogonally polarized beams)--background is medium intensity

Figure 10-6

Interference between O and E wavefronts in the image plane. The two views show the DIC prism adjusted for extinction (top) and with the addition of bias retardation (bottom). The pairs of graphs for each condition show the positions of wavefronts ( $\phi$ ) and the corresponding amplitudes ( $A$ ) for profiles taken through an object in the direction of prism-induced shear, which gives the greatest contrast. The x-axis represents the distance  $x$  across the object. The graphs indicating the phase shift  $\phi$  show the O and E wavefronts (labeled  $\Sigma_1$  and  $\Sigma_2$ ) in the image plane after passage through the objective DIC prism and analyzer. The dips in the wavefronts represent phase retardations resulting from transit through a phase object. The graphs of amplitude  $A$  show the wave resulting from interference between the two original wavefronts. Objective prism adjusted to extinction: Notice that under conditions of extinction, the two wavefronts in the top panel are sheared laterally by a distance  $a$  along the x-axis, but do not exhibit a phase difference in the regions corresponding to background. These regions have 0 amplitude and appear black in the corresponding intensity plot. Addition of bias retardation after movement of the objective DIC prism: The two wavefronts remain sheared by the same amount  $a$ , but are now relatively shifted in phase. The corresponding amplitude plot shows a bright edge on the left-hand side and a dark edge on the right-hand side. Moving the DIC prism changes the displacement between the two wavefronts along the y-axis and alters the contrast.

# How bias retardation works

- This results in the 3-D "shadow effect"

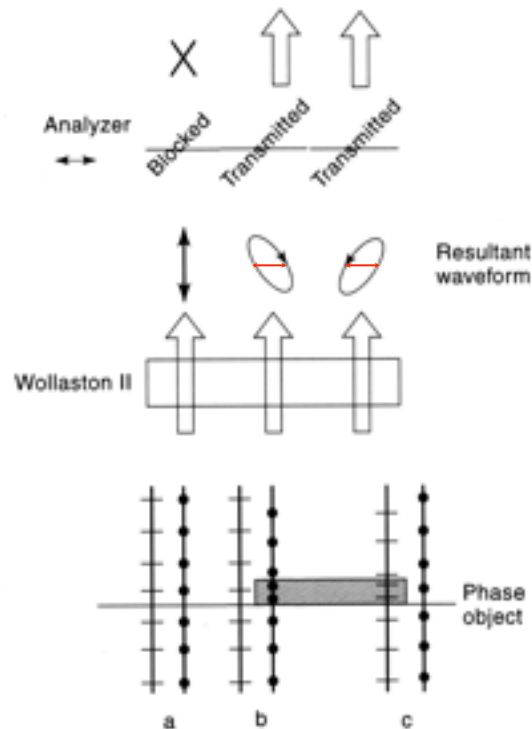

At maximum extinction, the analyzer doesn't "see" the different orientation of the ellipse of "b" as compared to "c". All the analyzer "sees" is the total vector contribution parallel to its plane of polarization

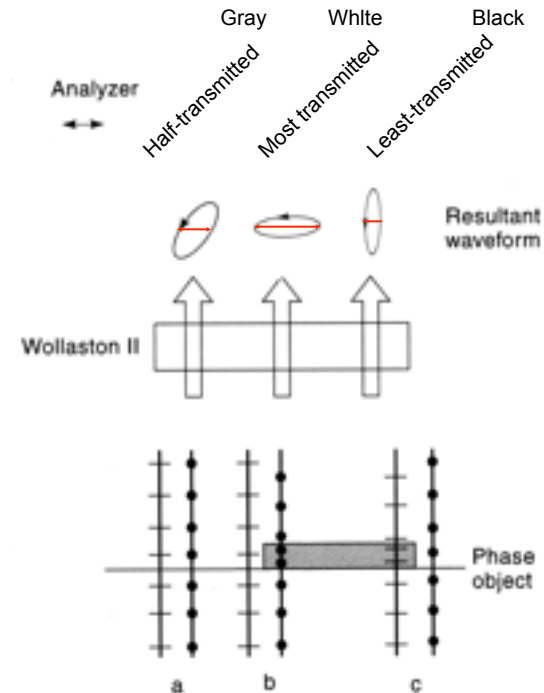

With bias retardation there is a systematic phase difference introduced by Wollaston II, such that light in "a" is already elliptically polarized. Now the difference between "b" and "c" is detected by the analyzer.

# Benefits of DIC

## Advantages

- With bias retardation can get very nice even contrast from the image
- Highest-resolution, because full aperture is used (often oil immersion condenser)
- No phase halo on thick specimens such as yeast
- Excellent optical sectioning, especially good for embryos/whole organisms

## Drawbacks

- Tissue culture plastic can be a problem
- Sometimes requires rotating stage to obtain full benefit (e.g. single microtubule detection)
- Expensive, on a small budget (but can plan for future by buying DIC nosepiece)

# Summary of contrast methods

- All of these methods are most easily understood in the context of the Abbe theory
- The notion of conjugate planes figures prominently, as does the importance of the objective back focal plane as a place where undiffracted light can be distinguished from diffracted light

**Darkfield:** By using a condenser N.A. greater than the objective N.A., 0th order undiffracted light is rejected at the objective back focal plane, and does not contribute to image formation. Only interference of higher-order diffracted light contributes to image formation. The result is that details of the specimen may be obvious, but extended specimens have relatively little contrast (great for E. coli, poor for tissue-culture cells)

**Phase contrast:** By placing an annulus at the condenser aperture plane, the sample is illuminated with a "hollow" cone of light rather than a "solid" cone. This means that at the objective back focal plane, all of the 0th order undiffracted light will appear as a ring, while most of the diffracted light will be inside or outside this ring. Introduction of a darkened annular quarter-wave ( $\lambda/4$ ) plate at the objective back focal plane results in a total  $\lambda/2$  ( $180^\circ$ ) phase shift of diffracted light relative to undiffracted light, as well as specific attenuation of the undiffracted light. At the image plane, interference of this "modified" diffracted and undiffracted light leads to good image contrast without sacrificing high-resolution

**DIC:** Wollaston prisms (one at the condenser aperture plane, and the other very close to the objective back focal plane) are used to create two parallel and orthogonally polarized beams (O-rays and E-rays) out of every beam that would be incident upon the sample. Any phase difference between O-rays and E-rays is converted into elliptically-polarized light when the rays are recombined. Bias retardation is further added to give the edge effect.

For further explanation and reinforcement, read on your own!